



Specification

Specification

- Model No. : PA.25 Anam
- Part No. : PA.25a
- Product Name : Hexa-Band Cellular SMD Antenna
GSM / CDMA / DCS / PCS / WCDMA / UMTS
/HSDPA / GPRS / EDGE
800 MHz to 2200 MHz
- Features : High Efficiency Multi-Band SMD Antenna
35*6*5mm
RoHS ✓



Measurements on above 110*40mm ground plane (EVB)

REVISION STATUS

Version	Date	Page	Revision Description	Prepared	Approved
02	May 19, 2009	All	Details of 6th Band added for TMobile 3g USA (1700MHz)	Ireland Head Office	Dermot O'Shea
03	Jul 30, 2009	All	Drawing updates	San Diego	Ruben F. Cuadras

© All Rights Reserved

Taoglas Limited, Unit 3 Enniscorthy Technology Centre, Enniscorthy, Co. Wexford, Ireland
www.taoglas.com



Specification

1. Introduction

This ceramic multiband cellular antenna uses high grade ceramics which have been developed in Taoglas through years of expertise in delivering the right materials for high performance antennas. Taoglas designers, through constant research and development have been able to “fit” 6 bands in a small area, while also achieving high efficiency. The PA.25 is a unique SMT solution which is delivered on tape and reel. For very detailed integration information additional to this specification please download our comprehensive PA-25 integration application note from our website.

1.1 Key Advantages

1. Highest efficiency in small size 36*6*5mm. A comparative metal, FR4, FPC, whip, rod, helix antenna would have much more reduced efficiency in this configuration for the same size due to their different dielectric constants.
2. More resistant to detuning compared to other antenna integrations. If tuning is required it can be tuned for the device environment. There is no need for new tooling, thereby saving money if customisation is required.
3. Highly reliable and robust– its predecessor the PA.22 antenna is used by the world’s leading auto makers in extremely challenging environments. The antenna meets all temperature and mechanical specs required (vibration, drop tests etc)
4. Rectangular shape - Easy to integrate. Other antenna designs come in irregular shapes and sizes making them hard to integrate.
5. SMD (On-Board) antenna saves on labor, cable and connector costs, leads to higher integration yield rates, and reduces losses in transmission.
6. It can be mounted directly on edge of device main-board.
7. Transmission losses are kept to absolute minimum resulting in much improved over the air (OTA) device performance compared to similar efficiency cable and connector antenna solutions
8. It exhibits a reduction in backward radiation toward the user’s head compared to other antenna technologies, thus minimizing the electromagnetic wave power absorption (SAR) which in turn enhances the antenna’s performance.
9. Reductions in probability of radiated spurious emissions compared to other antenna technologies are observed when using the PA-25 and strictly following this application note layout
10. Achieves moderate to high gain in both vertical and horizontal polarization planes. This feature is very useful in certain wireless communications where the antenna orientation is not fixed and the reflections or multipath signals may be present from any plane. In those cases the important parameter to be considered is the total field strength, which is the vector sum of the signal from the horizontal and vertical polarization planes at any instant in time.



Specification

2.0 Electrical Characteristics

No	Parameter	Specification
1	Working Frequency	824~960MHz to 1700~2170MHz
2	Dimensions	35*6*5mm
3	VSWR	3:1 max (depends on the special environment)
4	Polarization	Linear
5	Impedance	50 Ω
6	Operating Temperature	-40°C~+105°C
7	Termination	Ag (Environmentally Friendly Pb Free)

* Ground Plane Size 40*95 mm.

* Actual Electrical value will depend on customer ground plane size.



Specification

3.0 Key Antenna Performance Indicators

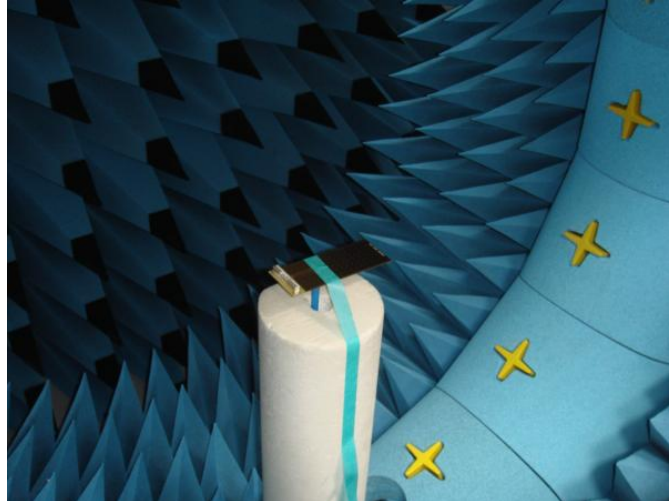

Measured in Satimo Starlab system

*Efficiency & Gain (Ground Plane Length: 95 mm)

Hexa-band Antenna PA-25a peak gain parameter Summary

Band	GSM (MHz)				3G	DCS (MHz)		PCS (MHz)		WCDMA (MHz)	
	824	890	880	960	1700	1710	1880	1850	1990	2110	2170
Peak Gain (dBi)	1.49	0.92	1.76	1.35	2.40	2.53	2.38	2.30	2.46	2.69	4.62
Efficiency (%)	60.6	65.4	69.3	64.6	51.0	54.7	63.1	61.6	51.5	56.2	65.8

Reference efficiency data with different ground plane length:

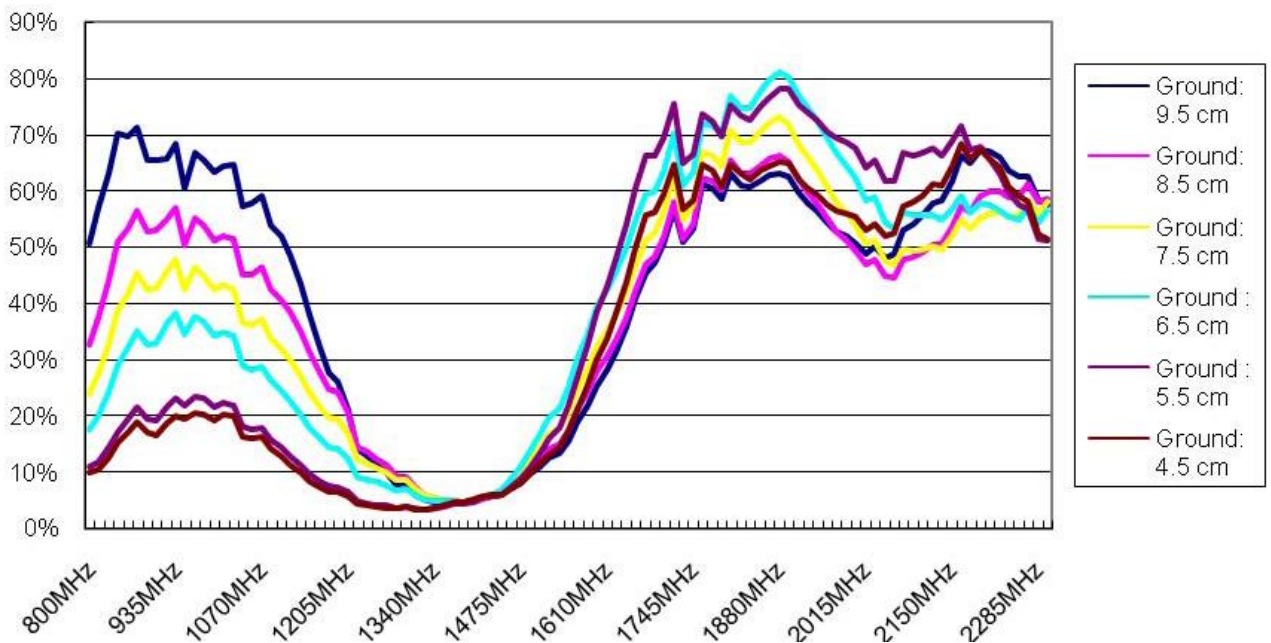

Return Loss & VSWR



Specification

Band	824	890	880	960	1700	1710	1880	1990	2110	2170
R L (dB)	-5.63	-9.70	-9.67	-7.16	-6.50	-9.34	-12.49	-9.60	-12.95	-13.07
SWR	3.26	2.03	2.02	2.50	2.03	2.03	1.66	1.93	1.54	1.59

S11 - Return Loss

S11 Log Mag 3.000dB/ Ref 0.000dB [F1]

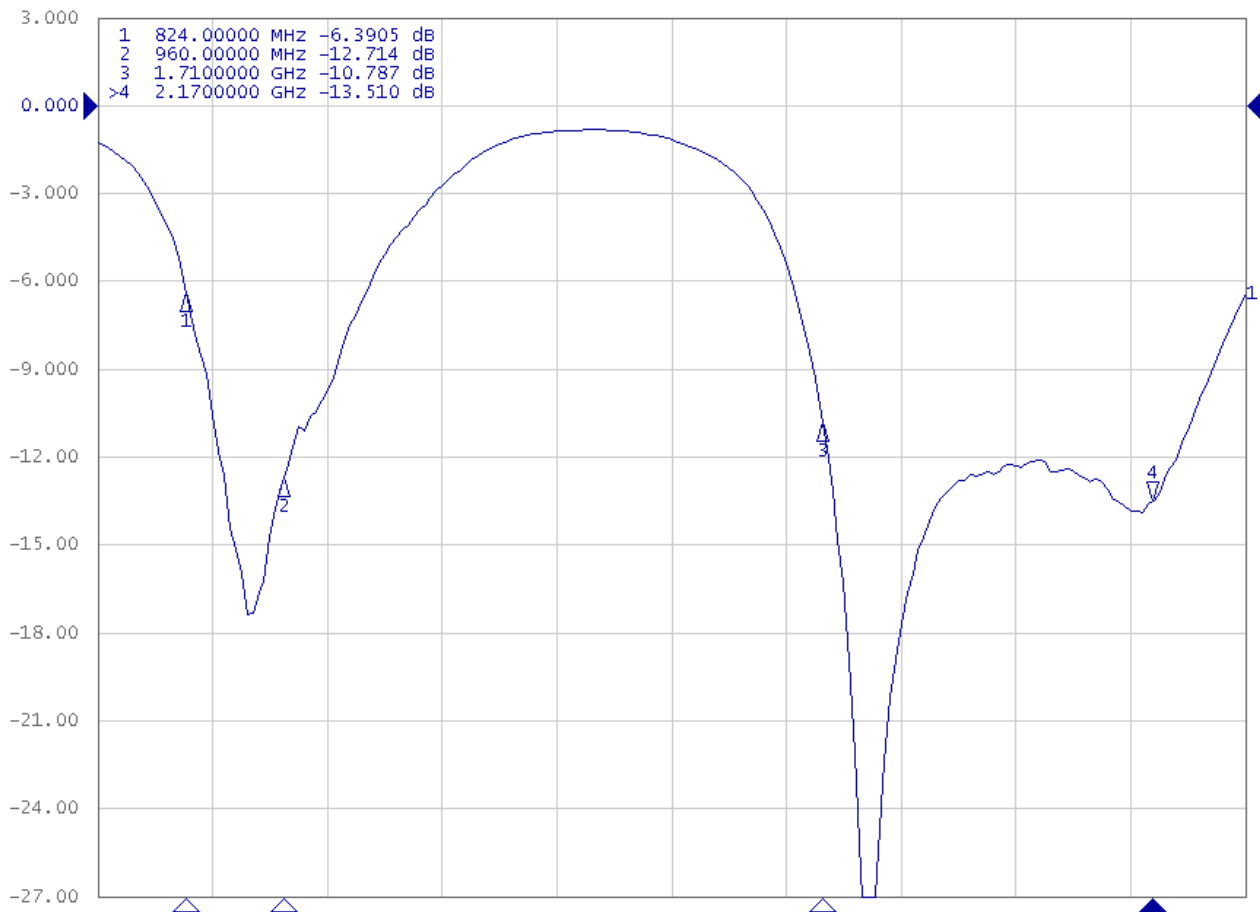

S11 – Smith Chart



Specification

▶ [F1] S11 Smith (R+jX) Scale 1.0000 [F1]

1	824.00000 MHz	32.824 Ω	-41.861 Ω	4.6141 pF
2	960.00000 MHz	51.214 Ω	29.208 Ω	4.8422 nH
3	1.7100000 GHz	31.210 Ω	8.0208 Ω	746.52 pH
>4	2.1700000 GHz	36.866 Ω	-11.950 Ω	6.1373 pF

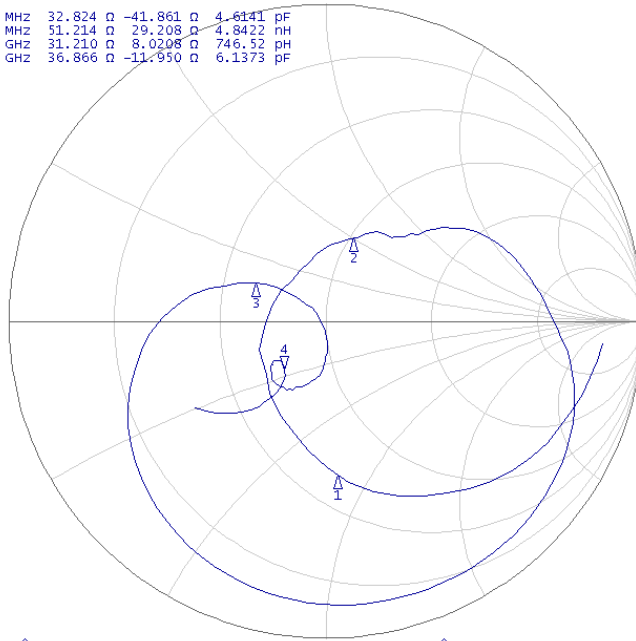

VSWR

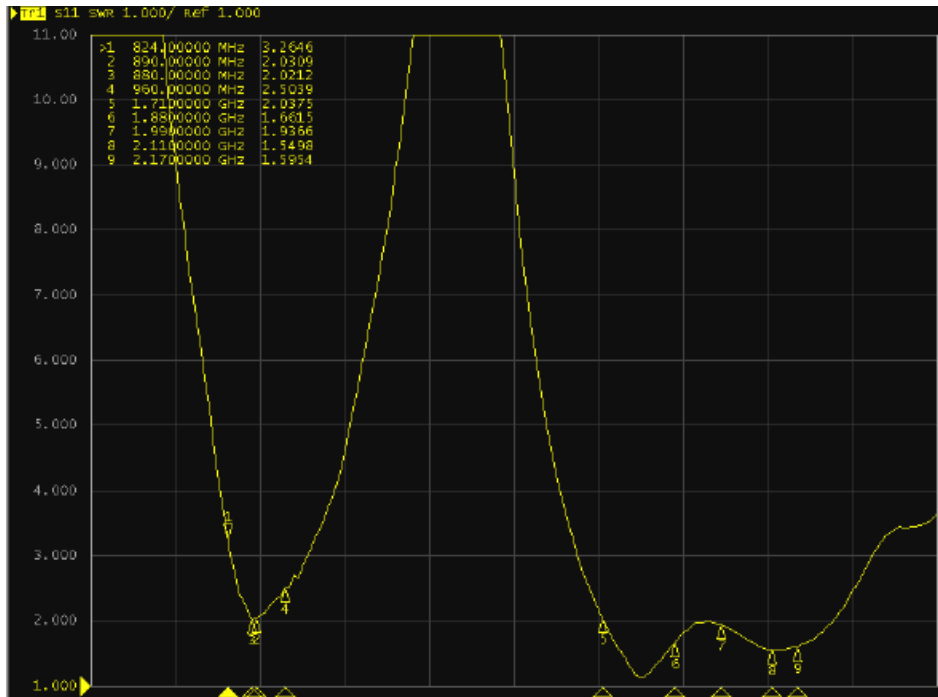

For Radiation patterns below note antenna cut planes



Specification

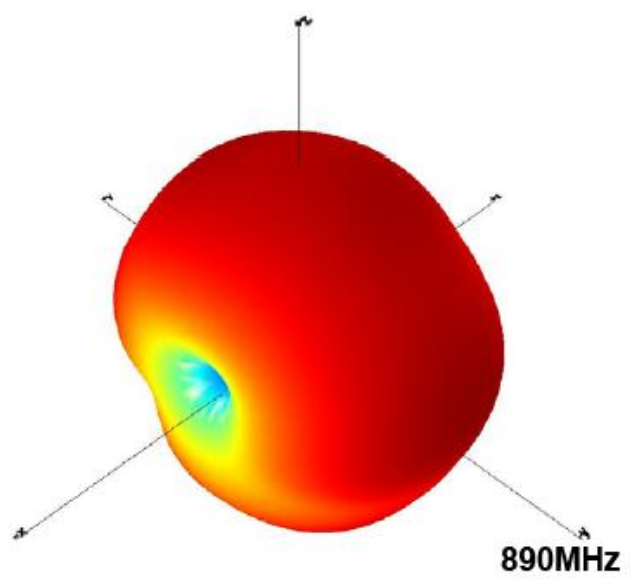
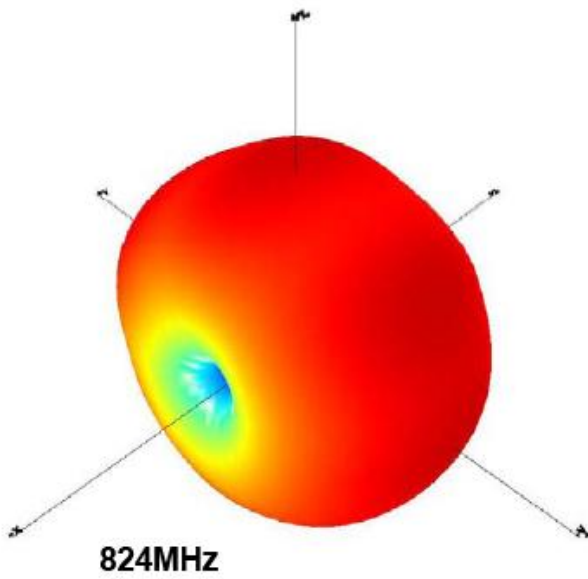
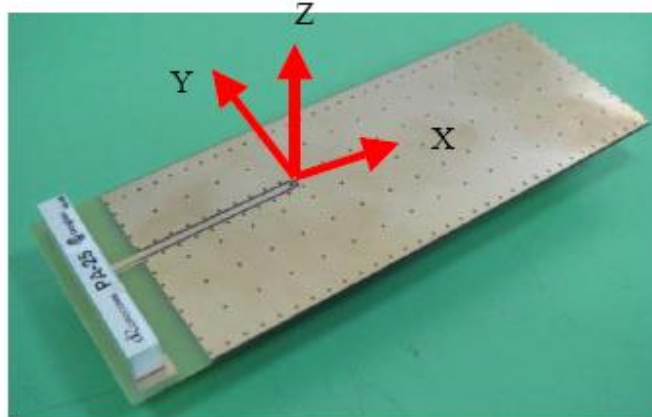



Specification

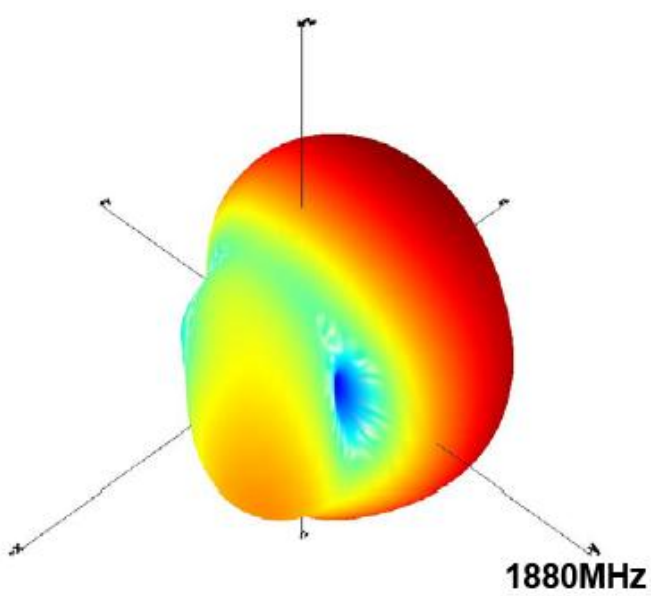
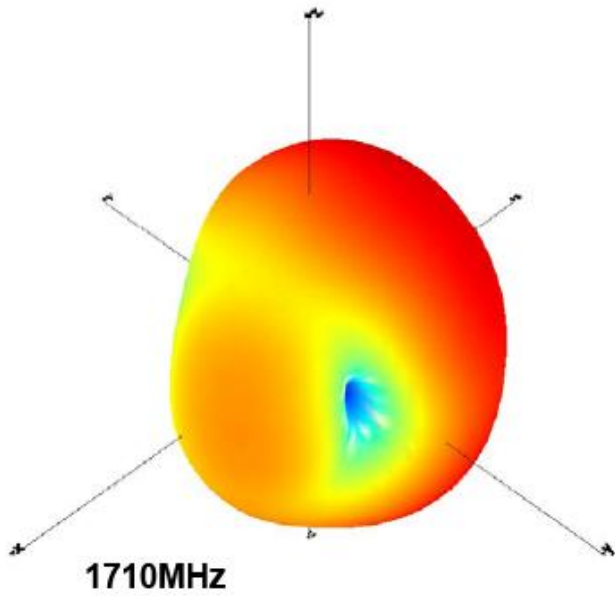
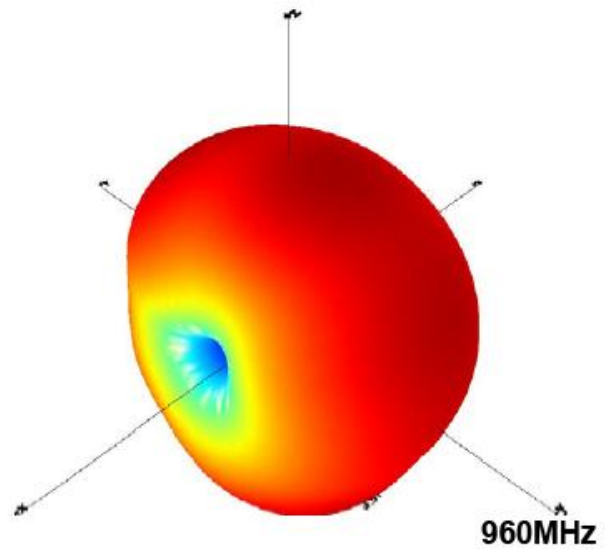
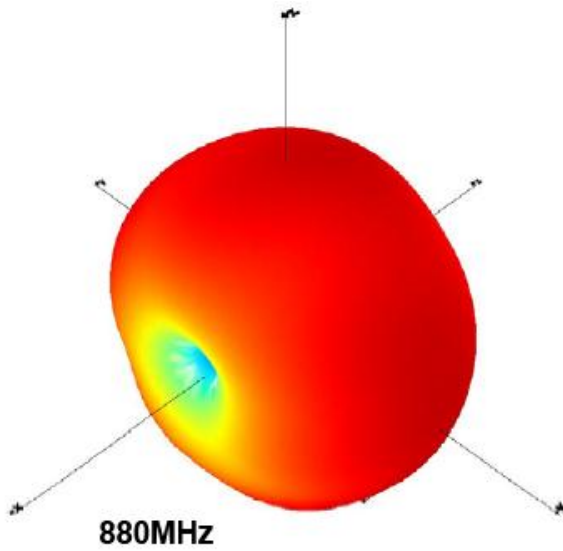

© All Rights Reserved
Taoglas Limited, Unit 3 Enniscorthy Technology Centre, Enniscorthy, Co. Wexford, Ireland
www.taoglas.com



Specification

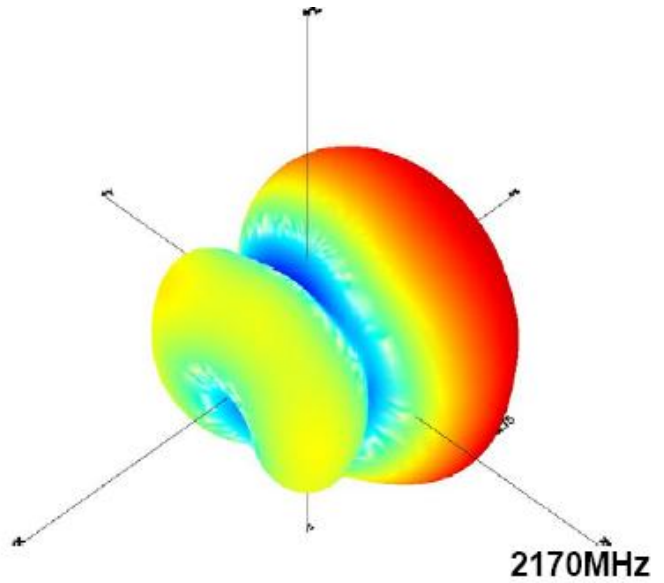
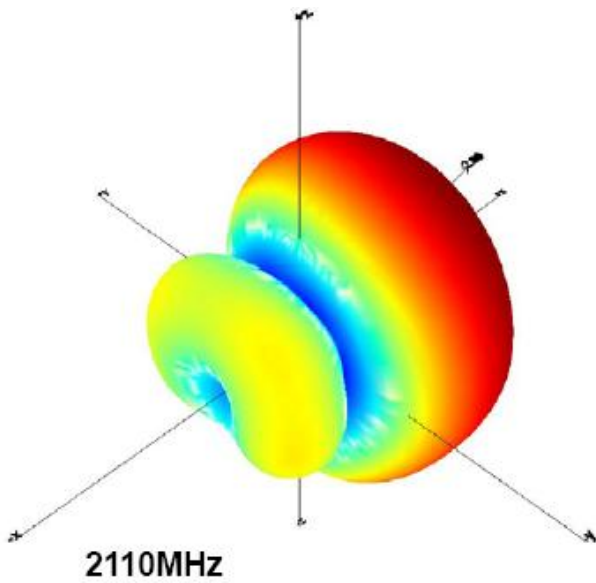
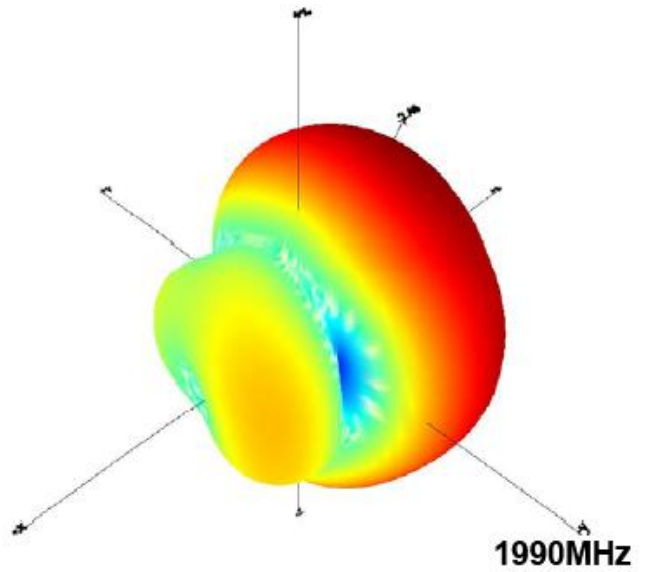
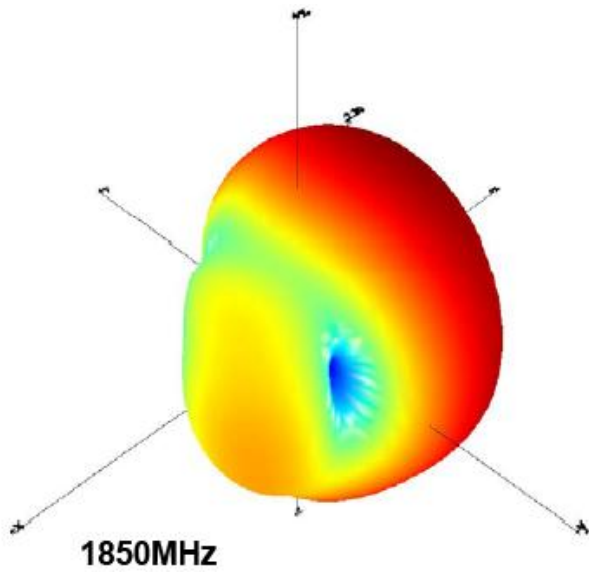

Test data below shows the affect of different ground plane lengths on the antenna in terms of antenna efficiency on all frequencies

	9.5cm	8.5cm	7.5cm	6.5cm	5.5cm	4.5cm
800MHz	51%	33%	24%	18%	11%	10%

© All Rights Reserved
 Taoglas Limited, Unit 3 Enniscorthy Technology Centre, Enniscorthy, Co. Wexford, Ireland
 www.taoglas.com



Specification

815MHz	57%	38%	27%	20%	12%	10%
830MHz	63%	44%	33%	24%	14%	13%
845MHz	70%	51%	39%	29%	17%	15%
860MHz	70%	53%	42%	32%	20%	17%
875MHz	71%	57%	45%	35%	22%	19%
890MHz	65%	53%	42%	33%	20%	17%
905MHz	65%	53%	43%	33%	19%	16%
920MHz	66%	55%	46%	36%	22%	19%
935MHz	68%	57%	48%	38%	23%	20%
950MHz	60%	50%	42%	34%	22%	19%
965MHz	67%	55%	46%	38%	24%	21%
980MHz	65%	54%	45%	37%	23%	20%
995MHz	63%	51%	43%	34%	22%	19%
1010MHz	64%	52%	43%	35%	22%	20%
1025MHz	65%	52%	42%	34%	22%	20%
1040MHz	57%	45%	37%	29%	18%	16%
1055MHz	58%	45%	36%	28%	18%	16%
1070MHz	59%	46%	37%	29%	18%	16%
1085MHz	54%	43%	34%	26%	16%	14%
1100MHz	52%	41%	32%	24%	14%	13%
1115MHz	49%	39%	30%	22%	13%	11%
1130MHz	43%	35%	27%	20%	11%	10%
1145MHz	38%	32%	24%	18%	10%	8%
1160MHz	32%	28%	22%	16%	9%	7%
1175MHz	28%	25%	20%	14%	8%	7%
1190MHz	26%	24%	19%	14%	7%	6%
1205MHz	21%	21%	17%	12%	7%	6%
1220MHz	14%	15%	12%	9%	5%	4%
1235MHz	13%	14%	12%	9%	5%	4%
1250MHz	11%	12%	11%	8%	4%	4%
1265MHz	10%	11%	10%	8%	4%	4%
1280MHz	8%	9%	9%	7%	4%	3%
1295MHz	8%	9%	9%	7%	4%	4%
1310MHz	6%	7%	7%	6%	4%	3%
1325MHz	5%	6%	6%	5%	3%	3%
1340MHz	5%	5%	5%	5%	4%	3%
1355MHz	5%	5%	5%	5%	4%	4%
1370MHz	5%	5%	5%	5%	4%	4%
1385MHz	5%	5%	5%	5%	5%	5%

© All Rights Reserved

Taoglas Limited, Unit 3 Enniscorthy Technology Centre, Enniscorthy, Co. Wexford, Ireland
www.taoglas.com



Specification

1400MHz	5%	5%	5%	5%	5%	5%
1415MHz	5%	5%	5%	5%	5%	6%
1430MHz	6%	6%	6%	6%	6%	6%
1445MHz	6%	6%	7%	7%	6%	6%
1460MHz	7%	7%	8%	9%	7%	7%
1475MHz	8%	9%	10%	11%	9%	8%
1490MHz	9%	11%	12%	14%	11%	10%
1505MHz	11%	13%	15%	17%	13%	11%
1520MHz	12%	14%	17%	20%	16%	13%
1535MHz	13%	15%	18%	21%	18%	15%
1550MHz	15%	17%	21%	25%	22%	17%
1565MHz	19%	21%	25%	30%	27%	21%
1580MHz	22%	24%	28%	34%	33%	25%
1595MHz	25%	28%	32%	39%	39%	30%
1610MHz	28%	31%	35%	42%	43%	34%
1625MHz	31%	34%	38%	46%	48%	38%
1640MHz	36%	38%	42%	50%	54%	44%
1655MHz	41%	42%	47%	55%	61%	50%
1670MHz	45%	47%	51%	59%	66%	56%
1685MHz	47%	49%	52%	60%	66%	56%
1700MHz	51%	52%	56%	63%	70%	59%
1715MHz	57%	58%	63%	70%	76%	65%
1730MHz	51%	52%	55%	61%	65%	57%
1745MHz	53%	54%	58%	63%	67%	59%
1760MHz	61%	62%	67%	72%	74%	65%
1775MHz	60%	62%	66%	71%	73%	64%
1790MHz	59%	60%	64%	70%	70%	61%
1805MHz	63%	65%	71%	77%	75%	65%
1820MHz	61%	63%	69%	75%	74%	63%
1835MHz	61%	63%	68%	75%	73%	62%
1850MHz	62%	65%	70%	77%	75%	64%
1865MHz	63%	66%	72%	80%	77%	64%
1880MHz	63%	66%	73%	81%	78%	65%
1895MHz	62%	65%	72%	80%	78%	65%
1910MHz	60%	62%	68%	77%	75%	62%
1925MHz	58%	60%	66%	75%	74%	60%
1940MHz	56%	58%	64%	72%	73%	59%
1955MHz	54%	55%	61%	69%	71%	58%
1970MHz	53%	53%	58%	67%	70%	57%

© All Rights Reserved

Taoglas Limited, Unit 3 Enniscorthy Technology Centre, Enniscorthy, Co. Wexford, Ireland
www.taoglas.com



Specification

1985MHz	52%	51%	56%	64%	69%	56%
2000MHz	51%	50%	54%	62%	68%	55%
2015MHz	49%	47%	51%	58%	64%	53%
2030MHz	50%	48%	51%	59%	66%	54%
2045MHz	48%	45%	47%	54%	62%	52%
2060MHz	49%	45%	47%	53%	62%	53%
2075MHz	53%	48%	49%	56%	67%	57%
2090MHz	54%	48%	49%	56%	66%	58%
2105MHz	56%	49%	49%	56%	67%	59%
2120MHz	58%	50%	50%	56%	68%	61%
2135MHz	58%	51%	50%	55%	66%	61%
2150MHz	62%	54%	52%	57%	69%	64%
2165MHz	66%	57%	55%	59%	72%	68%
2180MHz	65%	56%	53%	56%	68%	66%
2195MHz	67%	59%	55%	58%	68%	68%
2210MHz	67%	60%	56%	57%	66%	66%
2225MHz	66%	60%	56%	57%	63%	64%
2240MHz	63%	59%	55%	55%	60%	61%
2255MHz	62%	59%	56%	55%	58%	59%
2270MHz	63%	61%	58%	57%	57%	58%
2285MHz	58%	58%	56%	54%	52%	52%
2300MHz	58%	59%	58%	57%	51%	52%

4.0 Drawings

The next figure shows the layout for the antenna mounting



Specification

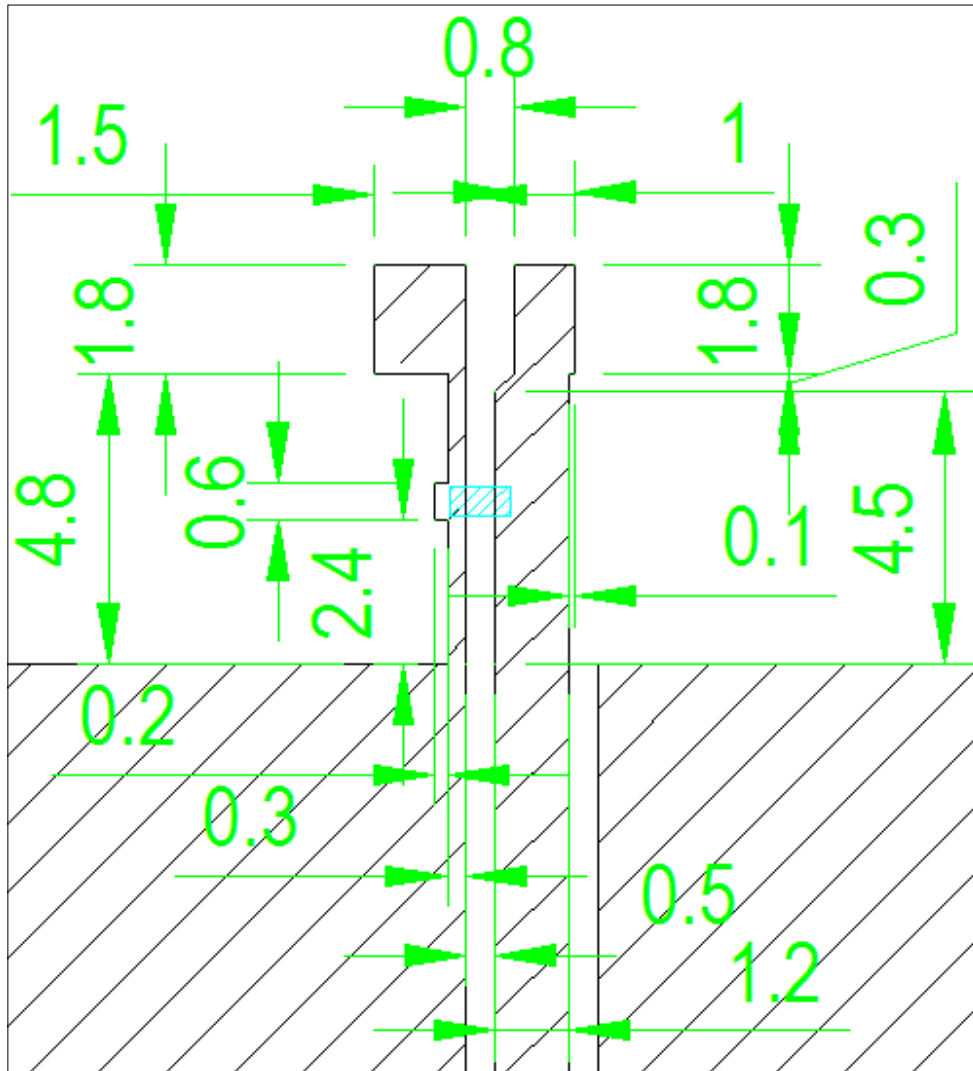

The size of the inductor is 0402. The layout has the area to allocate the inductor with a solder land of 0.6x0.5 m for each pad.

The next figure shows the solder area:



Specification

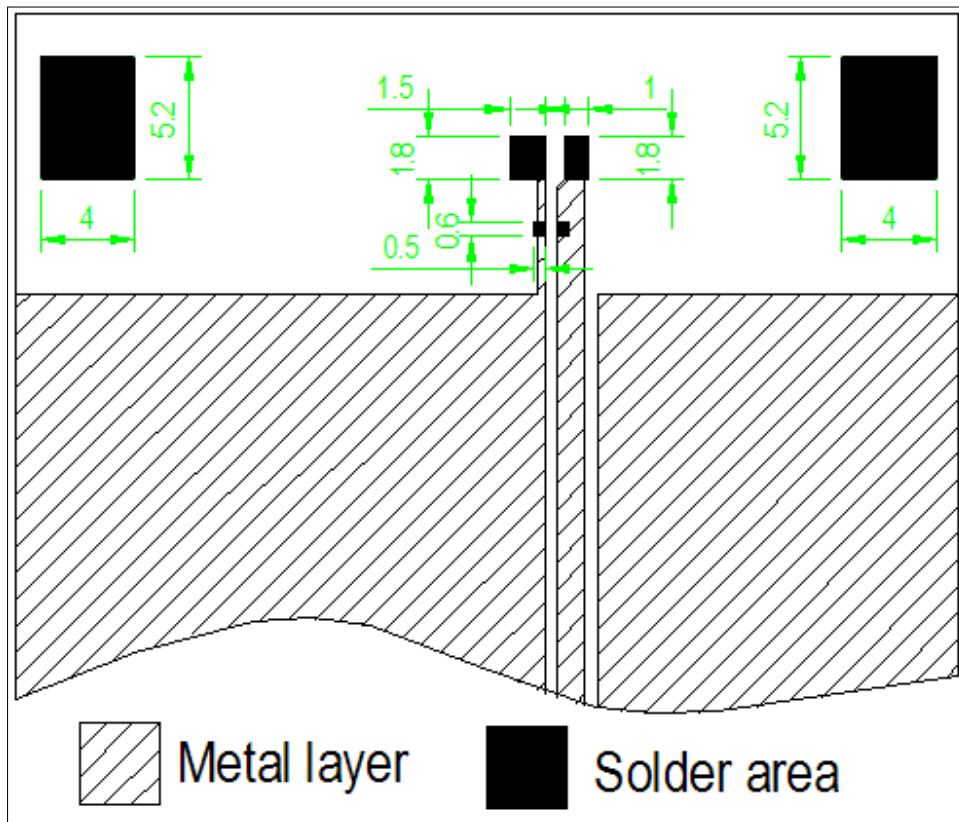

5.0 Test Board Dimensions

The test Board is designed for evaluation purposes with a SMA(F) Connector



Specification

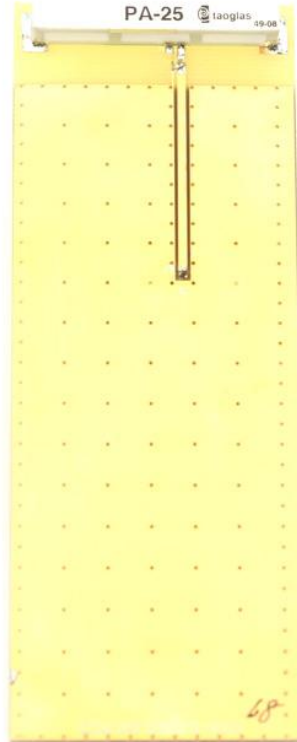

The size of the ground plane for the complete evaluation board is 95x40 mm. The size of the entire board including the antenna area free of ground plane is 106.8x40 mm. The area occupied by the antenna is 40x11.8 mm.

6.0 Transmission Line and Matching Component

A matching component of a 2nH inductor in parallel with PA-25 is required for the PA-25 to have the optimal performance in the evaluation board, located outside of the ground plane in the space specified in the above drawings.

The matching component in a device we recommend starting with a 6.8 nH for short ground planes (45-75 mm) and 2 nH for larger ground planes (80-100 mm). The inductor is strictly required in the antenna integration (this lumped element is considered as part of the antenna). It is not possible to determine if further improvement in matching is necessary for a PCB in specific, but we recommend incorporating in the design extra spaces for a “pi” network in between the GSM module and the edge of the ground plane. The starting point will be putting a 0 ohm resistor in series in the “pi” network (S1) and the required 6.8 nH or 2 nH outside of

© All Rights Reserved

Taoglas Limited, Unit 3 Enniscorthy Technology Centre, Enniscorthy, Co. Wexford, Ireland
www.taoglas.com



Specification

the ground plane (L1). With these spaces we have 3 options for matching topologies as in the next figures:

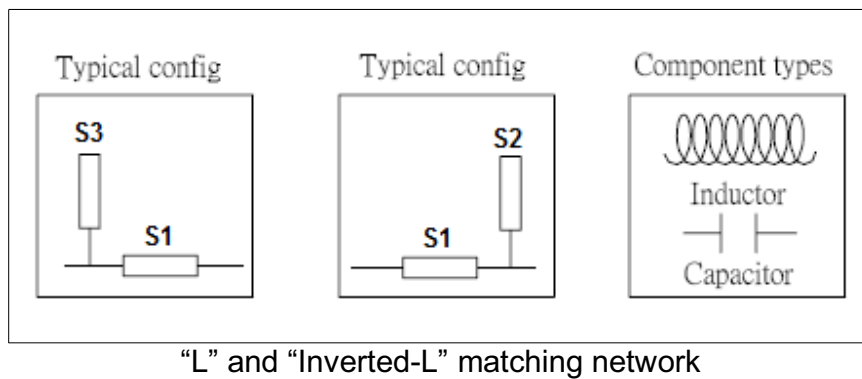
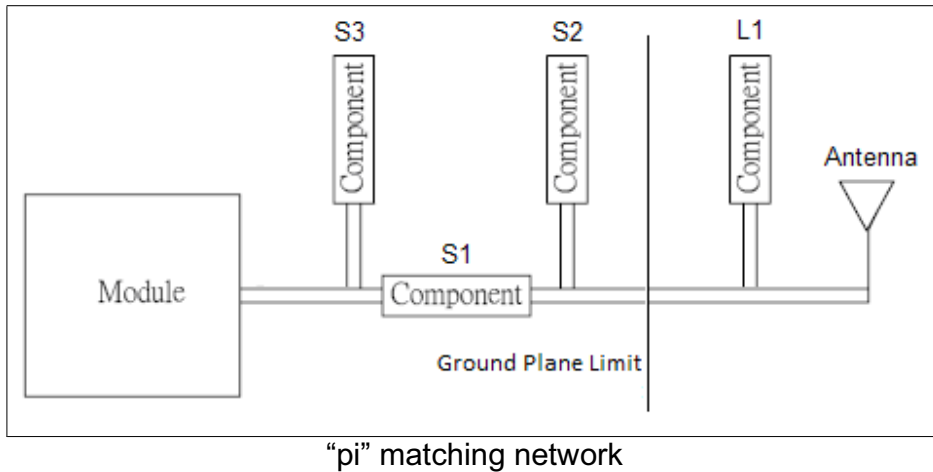

Further optimization could be done as part of a matching circuit to determine if more components are necessary in the “pi” network, but ca not be determined before, until we test the board with the antenna on it.

7.0 Recommended Reflow Temperature Profile

The PA-25 can be assembled following either Sn-Pb or Pb-Free assembly processes. The recommended soldering temperatures are as follows:

Phase	Profile Features	Sn-Pb Assembly	Pb-Free Assembly (SnAgCu)
Ramp-Up	Avg Ramp-Up Rate (Tsmax to Tp)	3°C/second (max)	3°C/second (max)



Specification

Preheat	Temperature Min (T_{smin}) Temperature Max (T_{smax}) Time (t_{smin} to t_{smax})	100° 150° 60-120 seconds	150° 200° 60-180 seconds
Reflow	Temperature (T_L) Total Time Above T_L (t_L)	183°C 60-150 seconds	217°C 60-150 seconds
Peak	Temperature (T_p) Time (t_p)	235°C 10-30 seconds	260°C 20-40 seconds
Ramp-Down	Rate	6°C/second (max)	6°C/second (max)
	Time from 25°C to peak Temperature	6 minutes max	8 minutes max

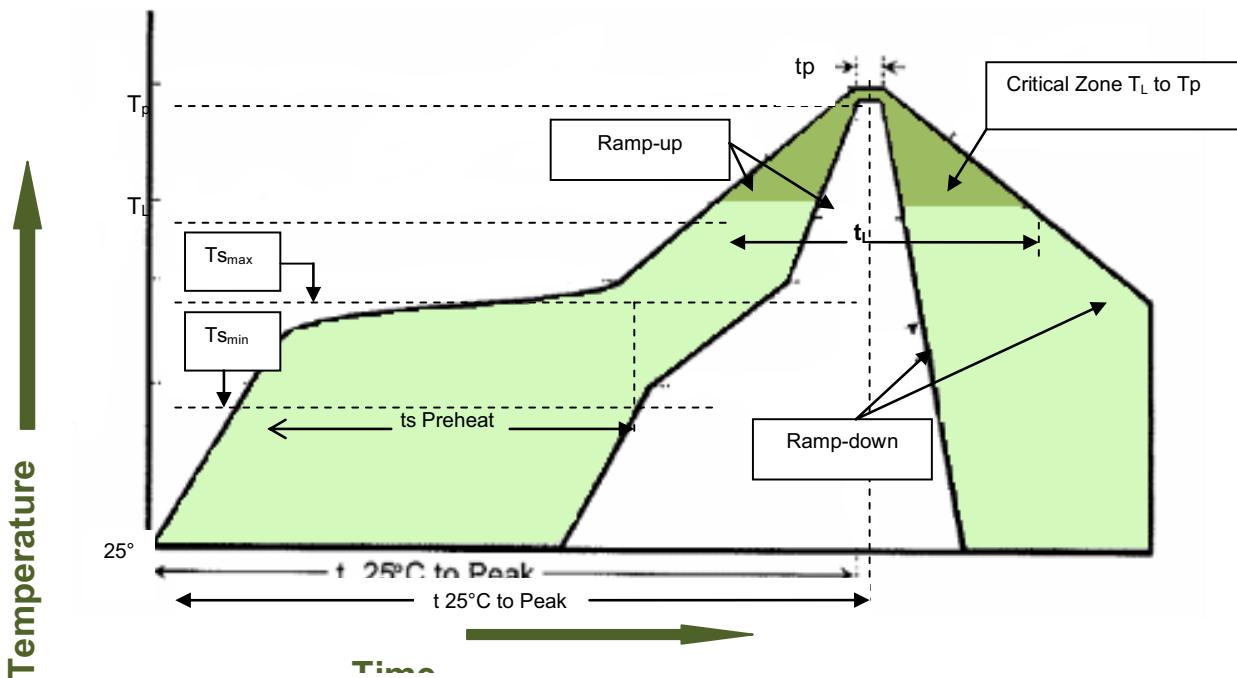

Temperature profile – (green area) for the assembly process in reflow ovens



Specification

8.0 Delivery Mode

1. Blister tape to IEC 286-3 , polyester ◦
2. Pieces/tape: 450

