

FEATURES

- △ Single-Chip Modem Controller
- △ Quick turnaround design cycle
- △ 'AT' Compatible command set
- △ Realise a full modem using a single crystal.
- △ Full autobauding 300-9600bps
- △ Direct interface to TDK 'k'series 'AL' and 'BL' modem devices
- △ Various package options.
- △ Supports V.21, V.22, V.22bis, V.23 (speed buffered), V.23 turn around data protocol, and V.42 packet support.

44-PIN PLCC PACKAGE

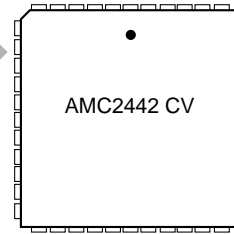

AMC2442CV

GENERAL DESCRIPTION

The AMC2442 Serial Modem Controller is designed to act as a fully stand alone modem controller device. To build a complete functional modem simply requires the addition of a modem front end circuit. The AMC2442 supports the 73K321, 73K222, 73K224, and 73K324 devices manufactured and supplied by TDK Semiconductor Corp. (USA) in both their AL and BL version where available.

Full autobauding is supported on the DTE interface at data speeds of 300, 600, 1200, 2400, 4800, and 9600 bps (19200 TBA), and the device runs from either an external clock

source or a single crystal running at 11.0592MHz. This makes the AMC2442 the perfect companion part to TDK devices, which use the same clock frequency.

The simplicity of the resulting modem design makes the AMC2442 ideal for use in applications where the modem is a secondary function, and where there is no wish to develop an in-house design capability.

Alpha Micro Components offers full engineering support on modem designs based on the AMC2442 and using a TDK 'k'Series analog front end.

APPLICATIONS

- Point of Sale (POS) Terminals
- Electronic fund Transfer (EFT) systems
- Remote access security systems
- Remote metering systems
- Least-Cost routing (LCR) systems
- Set-top-box billing modems (pay-per-view)
- Remote call logging apparatus
- Remote access terminals

BLOCK DIAGRAM

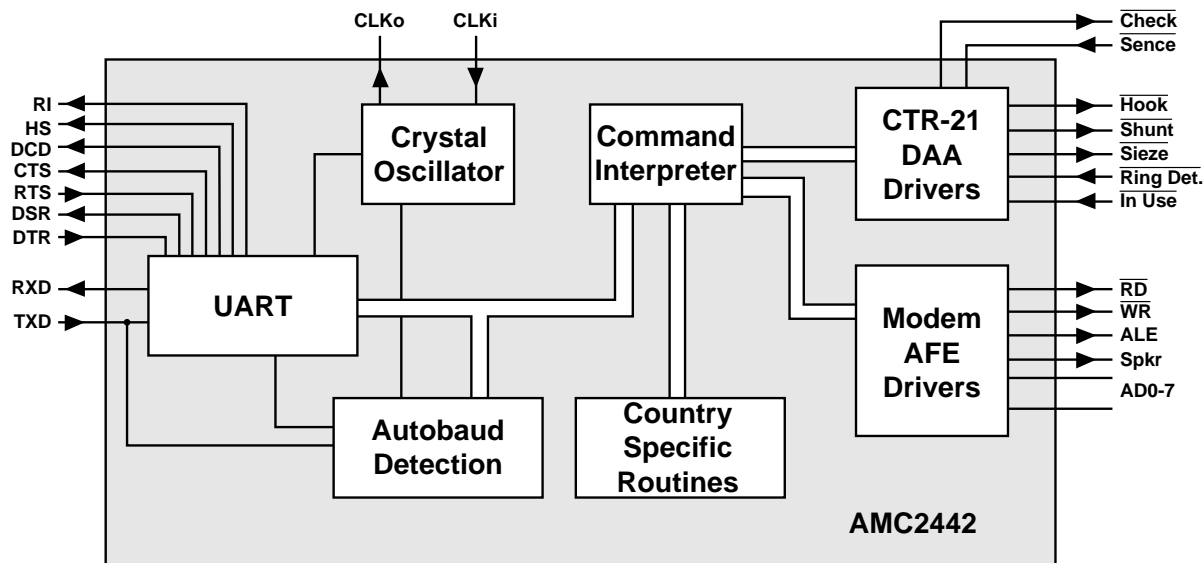

AMC2442 Serial Modem Controller with Pseudo-Synchronous V.42 packet support

PIN DESCRIPTIONS

Pin Name	PIN NUMBER			I/O TYPE	Description
	DIP	PLCC	QFP		
DCD	1	2	40	Output	DTE Data Carrier Detect output signal. Indicates modem has detected carrier.
RING	2	3	41	Input	Ring detector input. This pin assumes that a half wave opto coupler is used in the telephone line DAA circuit in the frequency detection algorithm.
RTS	3	4	42	Input	DTE Ready To Send input signal. Used for hardware flow control.
DTR	4	5	43	Input	DTE Data Terminal Ready input signal. Used to enable modem device
DSR	5	6	44	Output	DTE Data Set Ready output signal. Shows handshake training progress.
HS	6	7	1	Output	DTE High Speed output signal. Indicates V.22bis connections
RI	7	8	2	Output	DTE Ring Indicator. Follows the underlying cadence of any detected ringing signal
Free	8	9	3	I/O	DO NOT CONNECT
RESET	9	10	4	Input	Reset signal to the AMC2442 Controller. Active High.
TXD	10	11	5	Input	DTE Transmit Data Pin. All data communication from the DTE connects via this pin.
RXD	11	13	7	Output	DTE Receive Data Pin. All data communication to the DTE connects via this pin.
RXC	12	14	8	Input	Receiver Clock Input from AFE. Used in PSK, QAM and synchronous data mode.
TXC	13	15	9	Input	Transmitter Clock Input from AFE. Used in PSK, QAM and synchronous data mode.
Free	14	16	10	I/O	DO NOT CONNECT
CTS	15	17	11	Output	DTE Clear To Send output signal. Used for hardware flow control.
WR	16	18	12	Output	Write signal to AFE. Goes active low whenever the SMC wishes to write to the AFE
RD	17	19	13	Output	Read signal to AFE. Goes active low whenever the SMC wishes to read from the AFE
CLKo	18	20	14	Output	Buffered Clock output signal. Also used as a crystal drive signal when required.
CLKi	19	21	15	Input	Clock input signal. The SMC requires an 11.0592MHz signal on this pin.
GND	20	22	16	Power	SMC Ground connection
SPKR	21	24	18	Output	Speaker Enable drive
Free	22	25	19	I/O	DO NOT CONNECT
Free	23	26	20	I/O	DO NOT CONNECT
RLY	24	27	21	Output	DAA Line Seize relay control. Used if DPCO relay is used to share the telephone with a standard telephone instrument.
BS	25	28	22	Output	DAA Bell Shunt control. Used during LD dialling to provide a low impedance loop.
SENSE	26	29	23	Input	Line-In-Use detection input.
CHECK	27	30	24	Output	Line-In-Use circuit drive pin.
HOOK	28	31	25	Output	DAA Hook switch control. Delayed from Seize to allow for a low cost opto coupler.
NC	29	32	26	I/O	DO NOT CONNECT
LATCH	30	33	27	Output	ALE signal to AFE. Goes active high to latch an address into the AFE
VCC2	31	35	29	Power	Auxiliary power supply pin.
AD7->AD0	32->39	36->43	30->37	I/O	Multiplex Address / Data bus connections to AFE.
VCC1	40	44	38	Power	Main power supply pin.
NC		1	6	I/O	DO NOT CONNECT
NC		12	17	I/O	DO NOT CONNECT
NC		23	29	I/O	DO NOT CONNECT
NC		34	39	I/O	DO NOT CONNECT

CONNECTION DIAGRAMS

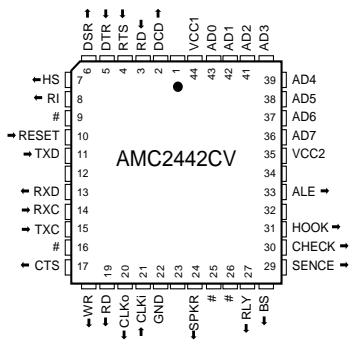

AMC2442CV Pinouts

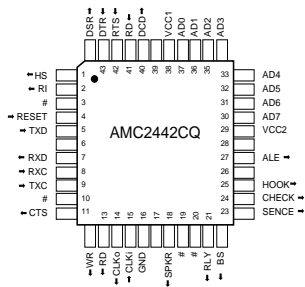

AMC2442CQ Pinouts

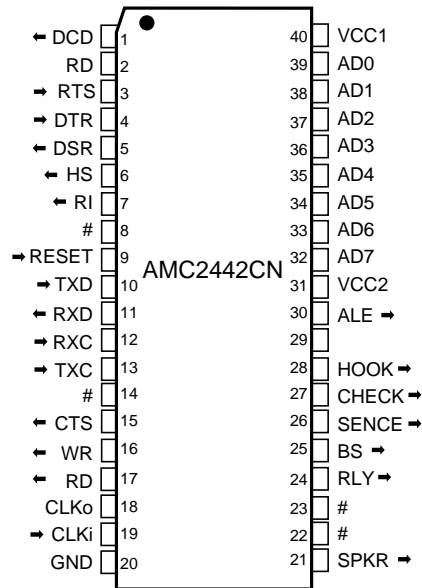

AMC2442CN Pinouts

FUNCTIONAL DESCRIPTION

The AMC2442 modem controller device has been designed as a single chip modem controller 'companion' to TDK Semiconductor Corp. 'k'-series Analog Front End circuits. The AMC2442 has been enhanced over previous controller designs by supporting both 'AL' and 'BL' modem variants in one device.

The AMC2442 will communicate serially with a DTE interface at data speeds up to 9600 bps (19200 tba). The controller does not need to be programmed to accept any specific data speed, as each time a new command is entered the characters are scanned to check what data speed (and parity) is being used. The available data speeds are: 300bps, 600bps, 1200bps, 2400bps, 4800bps, and 9600bps. The data format may be 8-bit no parity, 7-bit even parity, or 7-bit odd parity. Other data formats may be supported on request. Please contact Alpha Micro Components Ltd. directly for any specific requirements.

The serial DTE interface supports all the usual standard hardware control

signals, TXD, RXD, DTR, DSR, RTS, CTS, DCD, RI, and HS. The operation of each of these signals is explained below.

TXD: Transmit Data

The TXD pin receives data from the DTE interface

RXD: Receive Data

The RXD pin transmits data to the DTE interface

DTR: Data Terminal Ready

The DTR signal indicates when the DTE interface is in use. This pin is active low, and may also be toggled by the DTE during calls (see the AT&D command)

DSR: Data Set Ready

The DSR signal indicates to the progress of modem training. This pin is taken active low when received answer tone has been qualified.

RTS: Ready To Send

The RTS signal is used in data flow control, and indicates when the DTE buffer is overflowing. A logic '1' on this pin will stop data transfer when h/w flow control is selected (S31.1)

CTS: Clear To Send

The CTS signal is used in flow control, and indicates to the DTE that the modem buffer is overflowing. A logic 1 on this pin requests the DTE to stop sending data when h/w flow control is selected (S31.1)

DCD: Data Carrier Detect

The DCD signal is used to indicate to the DTE that the modem has detected a good carrier signal. This signal is active low, and is a debounced version of the detected line carrier signal (See S9, and S10)

HS: High Speed

The HS signal is used to indicate to the DTE that the local modem has connected to a far end modem in a high speed mode. In this instance, 'High Speed' indicates a data connection at V.22bis (2400 bps line speed).

RI: Ring Indicator

The RI signal is active low, and follows the underlying cadence of any received ringing signal on the telephone line. UK type dual ring cadences result in a single indication on RI

Command set

The AMC2442 modem firmware has been written in a minimum of internal ROM space in an effort to keep the overall cost of the modem controller component down. As a result it will be noticed that many of the familiar 'AT' commands are not supported in the AMC2442 but instead the user should be able to set any required options by directly programming the modem status (S) registers. Because of this, the method employed to program and interrogate the S-registers is more extensive than in traditional modems, and allows the user to chose any radix from binary, decimal, or hexadecimal.

Commands may be concatenated together with or without spaces between them to build up a complicated command line.

The maximum number of characters that may be entered on a single command line, including spaces, is 31.

The supported commands and S-registers are listed below.

A Answer call

The modem will seize the telephone line and generate answertone so that any remote modem can initiate an originate sequence.

B Data standard selection

B0	Selects CCITT data handshake TX and RX protocols
B1	Selects Bell data handshake TX and RX protocols
B2	Selects CCITT V.23 data protocol supporting the SOFT pingpong half duplex option
B3	Selects CCITT V.23 data protocol supporting the HARD pingpong half duplex option

C Carrier Indication

C0	DCD is held constantly active at logic 0
C1	DCD follows the state of detected carrier signal on the line.

D Start dialling and originate a call

Supported dialling modifiers are shown below

E Echo command characters

E0	No characters typed in command mode are echoed back to the DTE
E1	Echos all characters typed in command mode back to the DTE

F Master Reload (acts as ATZ)

Reload all S-Registers back to their ROM default values
Return to command mode ready for next command

H Hook switch control

H0	Drops the line and terminates any call in progress
H1	Seizes the line and draws line current (this may have to be time limited for some countries)

I Information String

I0	Displays the modem identification message AMC2442
I1	Displays the ROM checksum (set to 000)
I2	Checks the ROM for correct operation and returns OK if correct
I3	Displays the Alpha Micro Components Ltd Copyright message
I4	Displays the software version number
I5	Displays the part number of the TDK 'k'series modem AFE currently fitted

K Data Flow Control handshake selection

K0	Disable flow control support (dangerous if DTE speed is faster than line speed)
K3	Enable Hardware flow control using CTS and RTS
K4	Enable Software flow control using Xon and Xoff
K5	Enable both Hardware and Software flow control together

L Speaker Volume level

Lx Value of 'x' is ignored. This command is only to maintain Hayes™ modem command compatibility.

O Return to data mode from escape mode

O0	Simply reconnect modem data channel to remote modem
O1	Force a retraining request and reconnect to remote modem

M Speaker control modes

M0	Speaker is always OFF
M1	Speaker is ON after seizing the line, and switches OFF after a successful connection
M2	Speaker is always ON
M3	Speaker is ON after completing dialling, and switches OFF after a successful connection

S Select default S register

Sn	Selects the register 'n' from the legal list of registers
S\$n	Selects the register 'n' where n is in HEX
S%n	Selects the register 'n' where n is in BINARY

= Program default S-Register

=n	Saves the value n into the current default register (selected above)
=\$n	Saves the value n into the current default register where n is in HEX
=%n	Saves the value n into the current default register where n is in BINARY

? Display default S-Register

?	Displays the value in the current default register
?\$	Displays the value in the current default register in HEX
?%	Displays the value in the current default register in BINARY

V Modem response Verbose mode

V0	All standard modem responses are returned in numeric format
V1	All standard modem responses are returned in text format (+ carriage return/line feed).

W Result code reporting depth

W0	Report simple connection response (DTE speed only)
W1	Report Carrier speed, Connection Protocol and DTE speed on connection

X Modem result codes and dialling options

X0	Ignore "Dialtone", Ignore "Busy tone", Simple "Connect" messages
X1	Ignore "Dialtone", Ignore "Busy tone", add DTE speed to "Connect" messages
X2	Check for "Dialtone", Ignore "Busy tone", add DTE speed to "Connect" messages
X3	Ignore "Dialtone", Check for "Busy tone", add DTE speed to "Connect" messages
X4	Check for "Dialtone", Check for "Busy tone", add DTE speed to "Connect" messages

Y Async / Pseudo Sync selection

Y0	Select Asynchronous mode.
Y4	Enable Pseudo-synchronous modes and enable V.42 after connection
Y5	TDK Pseudo-synchronous mode selection (C-code V.42 support)
Y6	TDK Pseudo-synchronous mode selection (C-code V.42 support)
Y7	TDK Pseudo-synchronous mode selection (C-code V.42 support)

Z Master Reset

Reload all S-Registers back to their ROM default values
Return to command mode ready for next command

&D Set modem response to DTR signal during data call

&D0	Ignore DTR.
&D1	Modem moves from on-line to command state if DTR drops.
&D2	Modem hangs up call and returns to command state if DTR drops
&D3	Modem is RESET and will abandon current call if DTR drops

&F Master Reload (acts as ATZ)

Reload all S-Registers back to their ROM default values
Return to command mode ready for next command

&V Display ALL S-Register values

&V	List all the S Registers to the display. One line for each register
&V\$	List all the S Registers to the display in HEX format
&V%	List all the S Registers to the display in BINARY format

&Y Long Space Disconnect enable

Y0	Disable all long space generation and reception
Y1	Generate a long space when terminating a call, and terminate a call if modem receives a long space

Any commands not listed above will return an ERROR message and the command line will be terminated.

Legal S Registers

(struck out registers are fixed at their default value and will return ERROR if any attempt is made to read or write these locations):

Register	Default	Comment
S0	0	Number of rings to auto answer (0=no auto answer)
S1	0	Current count of ring cadences
S2	+	Escape character
S3	13	Carriage return character
S4	10	Line feed character
S5	08	Backspace character
S6	02	Blind dialling delay.
S7	45	Delay looking for carrier after dialling (sec)
S8	02	Dialling pause delay (sec)
S9	06	Carrier detection debounce time (100mS)
S10	14	Carrier loss debounce time (100mS) : 255=never drop
S11	100	DTMF digit on/of timing (mS)
S13	00	Country selection register
S14	12	Dialtone detection limit timer
S15	00001010	Bit mapped control register
S21	11110100	Bit mapped control register
S22	11110100	Bit mapped control register
S23	00000100	Bit mapped control register
S24	00	Mirror for S37 to be compatible with TDK V.42 driver 'C' Source code
S25	00	V.42 data mode enable
S26	00	Connection success code (1=Speed buffered, 2=MNP, 3=V.42)
S27	00000000	Bit mapped control register (select CCITT as default)
S30	00	Inactivity timer (0=disabled) - NOT IMPLEMENTED TBA
S31	00000001	Bit mapped control register
S37	00	Set maximum line speed (0=No limit : 4=V.21 : 5=V.22)
S40	00000000	Bit mapped control register
S91	138	Calling tone enable (128 +) and attenuation level (0-15dB)
S92	6	DTMF attenuation level 0 - 15dB
S93	8	Data attenuation level 0 - 15dB

S Register bit definitions

S15.7	Originate / Answer		
S15.6	Not used		
S15.5	Pulse / Tone default dialling select		
S15.4	Ignore / Action incoming commands -	NOT IMPLEMENTED	TBA
S15.3	Verbose / Numeric response messages		
S15.2	No results / Issue results selection flag		
S15.1	Echo / non echo commands back to console		
S15.0	Not used		
S21.7	Long Space Disconnect Enable / Disable		
S21.6	DSR Follows Answer tone / Always on		
S21.5	DCD Follows carrier / Always on		
S21.4	DTR drop control 1	00-ignore DTR	10-Hangup call
S21.3	DTR drop control 0	01-to command mode	11-Initialise modem
S21.2	CTS Follows RTS / Always on		
S21.1	Not used		
S21.0	Not used		
S22.7	33:66 / 40:60 pulse dialing ratio		

S22.6	Display speed along with CONNECT message		
S22.5	Accept / Ignore Busy tones after dialling		
S22.4	Look for dialtone / Blind dial		
S22.3	Speaker Control 1	00-Speaker off	10-Speaker on
S22.2	Speaker Control 0	01-Speaker on up to connection	11-Speaker on after dialling, up to connection
S22.1	Not used		
S22.0	Check / Ignore Parallel phone pick-up during calls -		TBA
S23.7	Guard tone enable 1		
S23.6	Guard tone enable 0		
S23.5	data length	1= 7 Bit data	: 0= 8 Bit data
S23.4	Parity	1= Even	: 0= Odd
S23.3	UART Speed 2	000 = 300 bps	: 001 = 600 bps
S23.2	UART Speed 1	010 = 1200 bps	: 011 = 2400 bps
S23.1	UART Speed 0	100 = 4800bps	: 101 = 9600bps : 110 = 19200bps
S23.0	Accept / Reject RDLB requests -	NOT IMPLEMENTED	TBA
S27.7	Enable / disable V.23	If S27.7=1 and S27.6=0 the modem enters V.23	
S27.6	CCITT / BELL	hardware half duplex (pingpong) mode	
S27.5	Not used		
S27.4	Not used		
S27.3	Sync/async mode selection bit 2		
S27.2	Sync/async mode selection bit 1		
S27.1	Not used		
S27.0	Sync/async mode selection bit 0		
S31.7	Ignore Answer tone (quick connect) - Only select in V.21 or V.23 modes		
S31.6	Not used		
S31.5	Not used		
S31.4	ATW high bit option save location		
S31.3	ATW low bit option save location		
S31.2	Line-In-Use prior to dialling Enable		
S31.1	Enable / Disable CTS:RTS flow control		
S31.0	Enable / Disable Xon:Xoff flow control		
S40.7	Accept cadenced dialtone as constant dialtone (for certain countries).		

Dialing Modifiers

Legal characters that can occur in the dialing string that are acceptable to the command line interpreter in the AMC2442 :

0	Dial a 0 in LD or MF dialing modes	
1	Dial a 1 in LD or MF dialing modes	
2	Dial a 2 in LD or MF dialing modes	
3	Dial a 3 in LD or MF dialing modes	
4	Dial a 4 in LD or MF dialing modes	
5	Dial a 5 in LD or MF dialing modes	
6	Dial a 6 in LD or MF dialing modes	
7	Dial a 7 in LD or MF dialing modes	
8	Dial an 8 in LD or MF dialing modes	
9	Dial a 9 in LD or MF dialing modes	
*	Dial a * in MF dialing mode. LD will ignore * characters	
#	Dial a # in MF dialing mode. LD will ignore # characters	
A	Dial an A in MF dialing mode. LD will ignore A characters	
B	Dial a B in MF dialing mode. LD will ignore B characters	
C	Dial a C in MF dialing mode. LD will ignore C characters	
D	Dial a D in MF dialing mode. LD will ignore D characters	
,	Insert a pause in the dialing the length of S8 seconds (between s8-1 and s8)	
T	Switch to tone or MF dialing	
P	Switch to pulse or LD dialing	
;	Return to command mode after dialing	
W	Wait for dialtone before progressing -	NOT IMPLEMENTED
@	Wait for silence before progressing -	NOT IMPLEMENTED
!	Dial a register recall hook flash -	NOT IMPLEMENTED

Hardware V.23 Half-Duplex PINGPONG mode (Set S27 set to 11000000 or ATB3)

Pingpong V.23 connections have the advantage of allowing data transmission at 1200 bps in each direction with a single V.23 link. The disadvantage is that only one terminal may 'speak' at the high data rate at any one time, and that external control signals must be used to swap the direction of the link. In the current implementation of hardware pingpong V.23 the AMC2442 uses the RTS,CTS and DCD hardware signals to help control the link as explained below:

Initiate a modem connection with the S27 register set for pingpong operation (S27=128), and connect with RTS held false. This will allow the link to connect as a standard V.23 originating modem and handshake with the far end device. Once a connection has been established, the two modems may communicate with the AMC2442 as the originating end (TX 75 bps / RX 1200 bps). When required the far end may either send a data command to instruct the AMC2442 host to swap direction, or simply swap direction itself. This will cause DCD to drop, and signal to the AMC2442 host that the far end has swapped. To swap the AMC2442 into the answer band (TX 1200 bps / RX 75 bps) simply take the RTS line TRUE. This will mute the transmit audio signal, wait for the new carrier to settle, re-enable the output audio signal, and then signal to the host that it is safe to send data by taking the CTS line TRUE.

To return the AMC2442 to the originate band, take the RTS line FALSE. This will take the CTS line FALSE, mute the transmit audio signal, wait for the new carrier to settle, re-enable the output audio signal. DCD will be reasserted TRUE once the far end modem has been detected once again.

Software V.23 Half-Duplex PINGPONG mode (Set S27 set to 10000000 or ATB2)

Software Pingpong to the Canal+ specification is also implemented on this software release. Software Pingpong is entered when the modem initiates a link with S27 set to 10000000. The modem swaps the V.23 1200bps and 75bps channels in response to particular data packets being transferred between the two modem units. As this protocol is proprietary to Canal+ it cannot be described in this data sheet, however Alpha Micro Ltd.'s proprietary algorithm has been extensively tested against a Canal+ "Half duplex" server to ensure that it meets the Canal+ requirements.

Returning to Command mode (the ESCAPE sequence '+++').

Following a successful modem connection the modem will enter "Data" mode. After this, all characters sent to the modem via the DTE interface will be regarded as simple data and be transmitted to the remote connection. This raises one major problem. Simply, how can one instruct the modem to drop the line at the end of a call, as no commands can be sent to the modem once it is in data mode. The answer is provided by means of the "Escape" sequence.

The Escape sequence is simply a strictly defined number of events that must be executed in the correct order so that the modem knows that the DTE wants to retake control of the link. The order required is that below :

- 1) The modem TXD input must receive a constant logic 1 for over 1 second (stop all transmit data flow).
- 2) The first character received must be the '+' character.
- 3) The next character received must also be the '+' character.
- 4) The final character received must also be the '+' character.
- 5) The modem TXD input must receive a constant logic 1 for over 1 second (stop all transmit data flow).

If ALL the above commands occur, in order, the modem will return the OK response, the connection will remain established, and the modem is ready to accept commands once more. The most usual command to issue at this point is either the ATH or ATH0 command to terminate the current call, but there is no reason why any of the command listed above cannot be given to the modem. If the DTE wishes to re-establish data mode once again, then this can be done by using the ATO command explained above.

Block Diagram

The AMC2442 modem controller has been designed to connect directly to the TDK Semiconductor Corp. modem analog front end circuits, with the minimum of additional components or glue logic. As a result, a modem designed around the AMC2442 and a TDK 'k' series modem part can be as simple as shown below.

Standard and tested DAA schematics are available for many countries worldwide, and multiple country approvals are supported in the standard device. Many other countries are available upon request. Please contact Alpha Micro Components Ltd. directly for the most up to date list of country trials and approvals with this design.

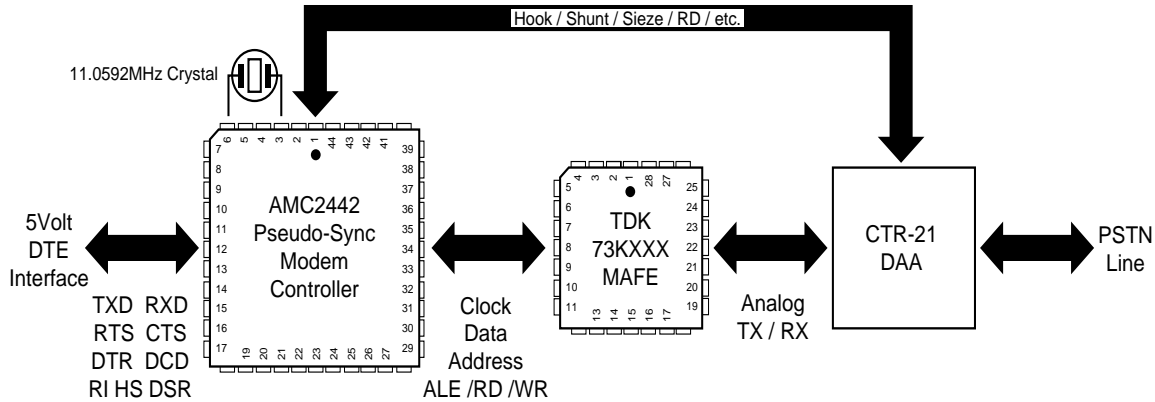

Single Crystal Modem Block Diagram using the AMC2442 Serial Modem Controller

Typical modem P.C.B. Layout using the AMC2442 modem controller

A typical working modem based on the block diagram shown above, may be easily realised on a small P.C.B as shown :

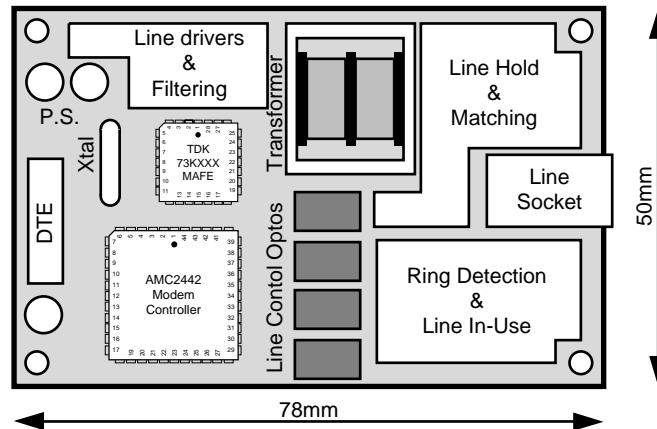

The design above is reproduced actual size, and uses the AMC2442 device together with a 'k'-series modem AFE from TDK Semiconductor Corp. This design supports mixed dialling, ring detection and parallel telephone off-hook detection all on a double sided P.C.B. measuring 50mm by 78mm.

Smaller layouts have been realised in-house on PCBs as small as 2.5 inches by 1 inch !.

The chart below shows which TDK modem AFE component to chose depending upon what data speeds are to be supported by the finished modem design. The AMC2442 is designed to detect which AFE has been fitted and adjust its operation accordingly.

TDK 'k'Series AFE selection chart

TDK Part number	V.21	V.22	V.23	V.22bis
73K321	✓		✓	
73K222	✓	✓		
73K224	✓	✓		✓
73K324	✓	✓	✓	✓

For further details on this product contact :



**Springfield House
Cranes Road
Sherborne St. John
Basingstoke
Hampshire
RG24 9LJ
UK**

**Tel: 01256 851770 (International +44 1256 851770)
Fax: 01256 851771 (International +44 1256 851771)**

**e-mail : alpha_micro@compuserve.com
<http://www.alphamicro.net>**