

AMC-CELLSTRIP11

Type	Cellular/Wi-Fi/Bluetooth Flexible T-Bar Antenna
Frequencies	AMPS (824 - 894MHz) GSM (900MHz) DCS (1800MHz) PCS (1900MHz) 3G (UMTS 2.1GHz) LTE (699 - 960/1710 - 2690 MHz) Wi-Fi/Bluetooth (2.4GHz)
Mounting	Adhesive/glass mounting



1. Specification

Frequencies	AMPS (824 - 894MHz) GSM (900MHz) DCS (1800MHz) PCS (1900MHz) 3G (UMTS 2.1GHz) LTE (699 – 960/1710 – 2690MHz) Wi-Fi/Bluetooth (2.4GHz)
Impedance	50 Ohms
Polarization	Linear
Gain	2.14 dBi
VSWR	Full 4G/LTE: <5:1 / Europe: <2:1
Power handling	25W
Operating temperature	-40°C to +85°C
Connector type	Specify (straight SMA male standard)
Cable type	RG174U
Material	PVC
Max. dimensions	117.4mm(L) x 12.5mm(W) x 6.7mm(D)
Weight	50g (with 2.5m cable length & SMA connector)
Colour	Black (also available in white)

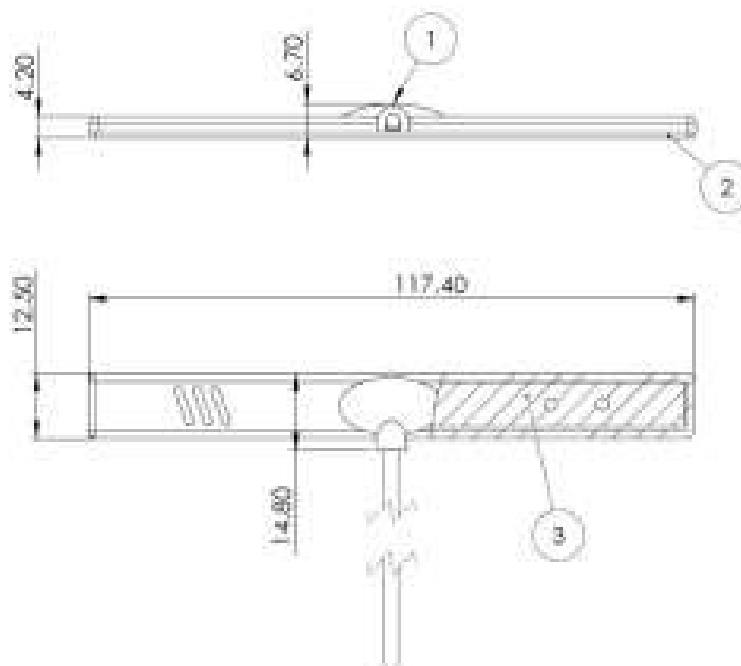

2. Measurement

S11

Tested with 300mm RG-174 cable length and 6mm thick glass

Log-Mag (Quad band)

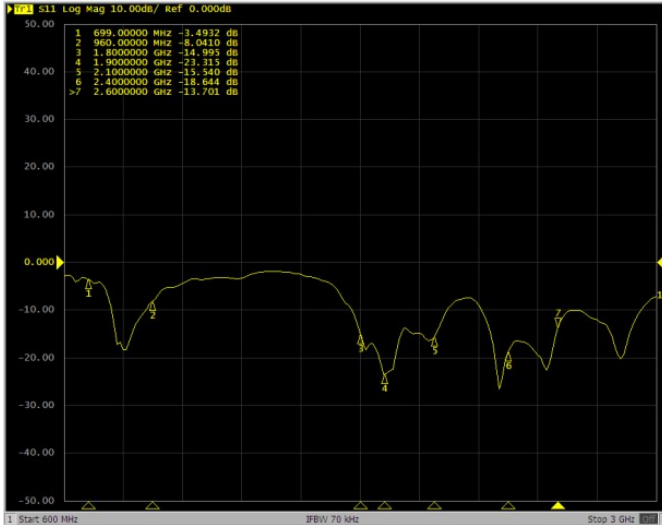

VSWR (Quad band)

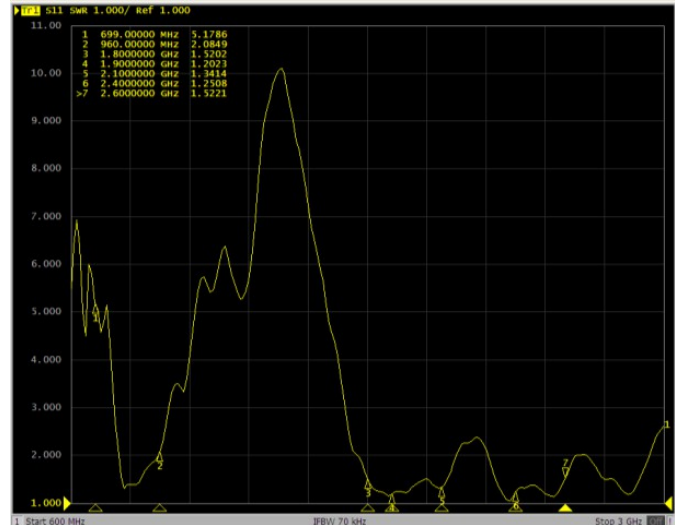

3D Spherical

Legend bar is showing antenna gain

Freq = 0.8500GHz Az= 45 EL= 45

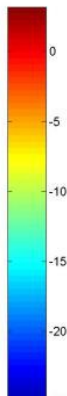
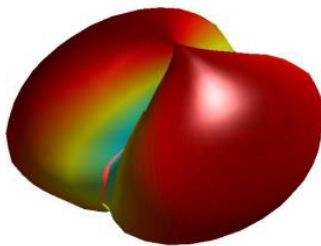

Freq = 0.9GHz Az= 45 EL= 45

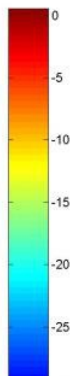
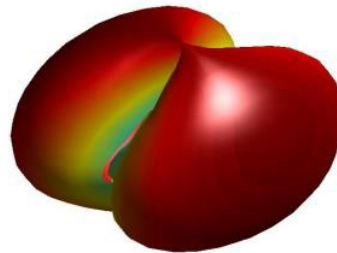

Freq = 1.8GHz Az= 45 EL= 45

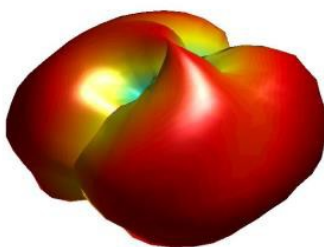

Freq = 1.9GHz Az= 45 EL= 45

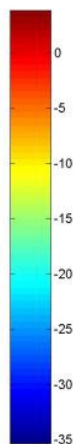
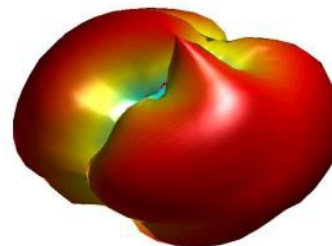

Freq = 2.1GHz Az= 45 EL= 45

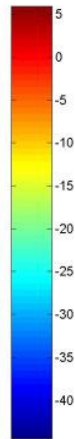
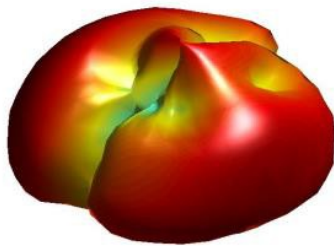

Freq = 2.41GHz Az= 45 EL= 45

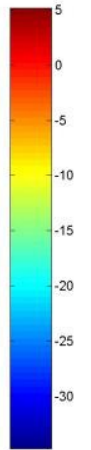
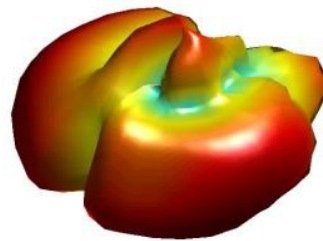

Freq = 2.6GHz Az= 45 EL= 45

