

## AMC-ANT672BT

**Type** 2.4/5.0GHz ISM Antenna

### Key Features

- 2.4/5.0GHz ISM
  - 2410 – 2490MHz
  - 4920 – 5925MHz
- Anti-rotation mechanism
- Ground plane independent
- IP67/IP69K ratings (IK09 and IK10 optional)
- Screw mount



### Certifications:



UK Tel: +44 (0)1256 851770 | Fax: +44 (0)1256 851771 | email: [sales@alphamicro.net](mailto:sales@alphamicro.net)  
[www.alphamicro.net](http://www.alphamicro.net)

## 1. Antenna and Electrical Specifications

Parameters	2.4/5.0GHz Antenna	
Standards	Wi-Fi, Bluetooth, ZigBee, ISM	
Band (GHz)	2.4	5.0
Frequency (MHz)	2410 - 2490	4920 - 5925
Return Loss (dB)	~-20	~-15
VSWR	~1.2:1	~1.4:1
Efficiency (%)	~35	~33
Peak Gain (dBic)	~4.3	~1.8
Average Gain (dB)	~-4.4	~-4.8
Impedance (Ohms)	50	
Polarisation	Linear	
Radiation Pattern	Omni-directional	
Max. Input Power (W)	25	
Connector Type	Specify (RP-SMA male – standard)	
Cable Length	Any cable length (3 meters – standard)	
Cable Type	Other cables available (RG174 – standard)	

### Measurement Conditions:

- Mounted on 30cm x 30cm ground plane
- 2m RG174 cable
- Measured in certified CTIA 3D anechoic chamber

## 2. Mechanical and Environmental Specifications

<b>Mounting Type</b>	Screw mount
<b>Dimensions (mm)</b>	Ø 77.3 x 36.5(h)
<b>Radome</b>	PC/ABS UV stable
<b>Colour</b>	Black
<b>Gasket</b>	TPE
<b>Antenna Base</b>	Zamak
<b>Operating Temperature (°C)</b>	-40 to +85
<b>Storage Temperature (°C)</b>	-40 to +85
<b>Certificates</b>	IP67, IP69K (IK09 and IK10 optional)
<b>Substance Compliance</b>	RoHS

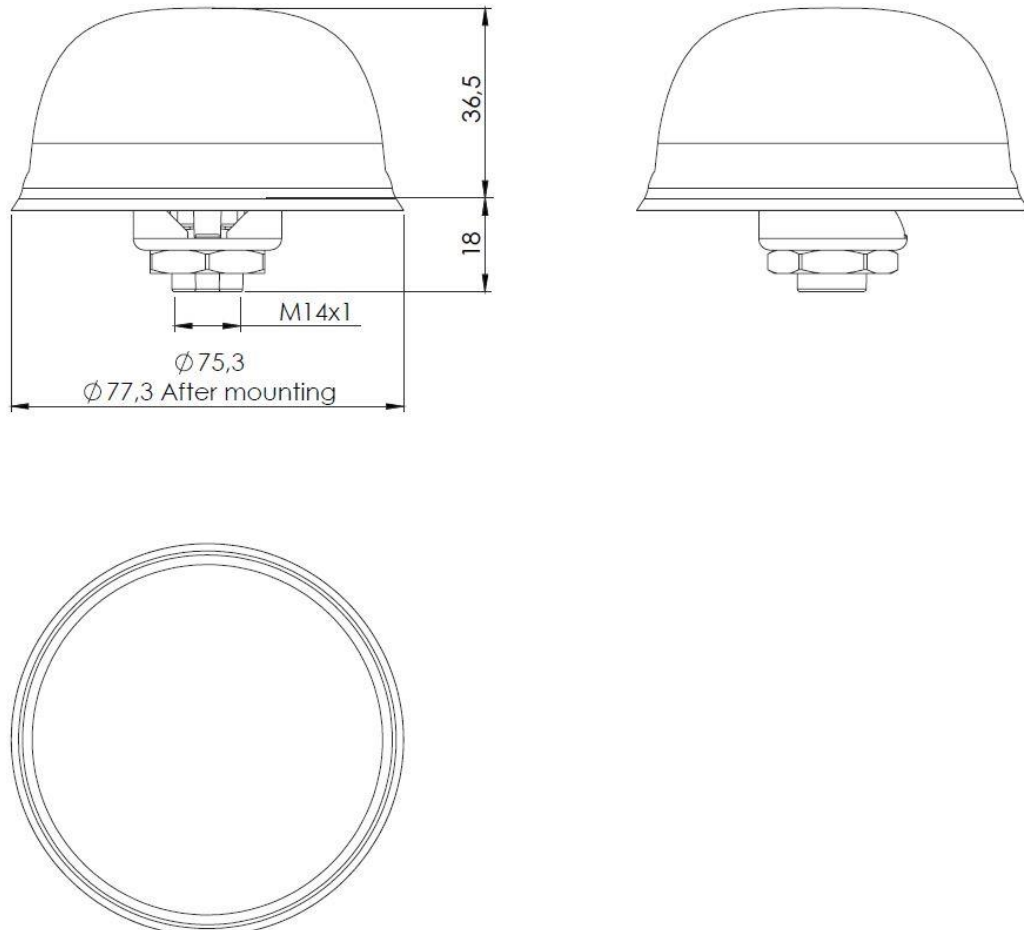

### 3. Antenna Parameters

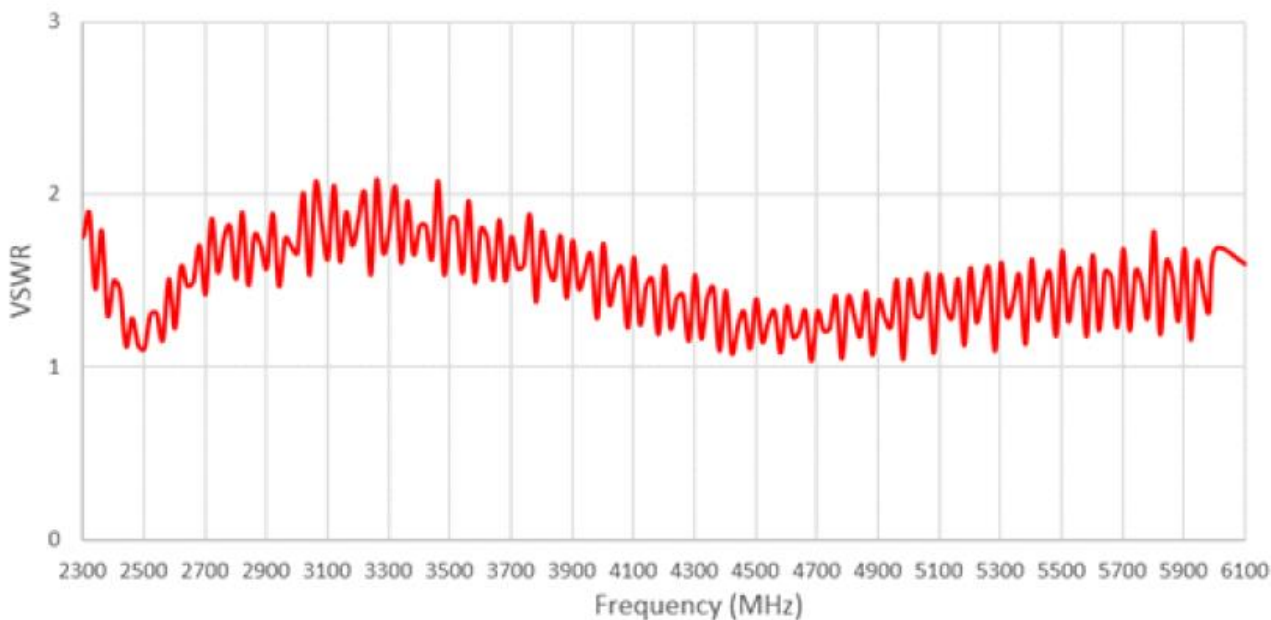
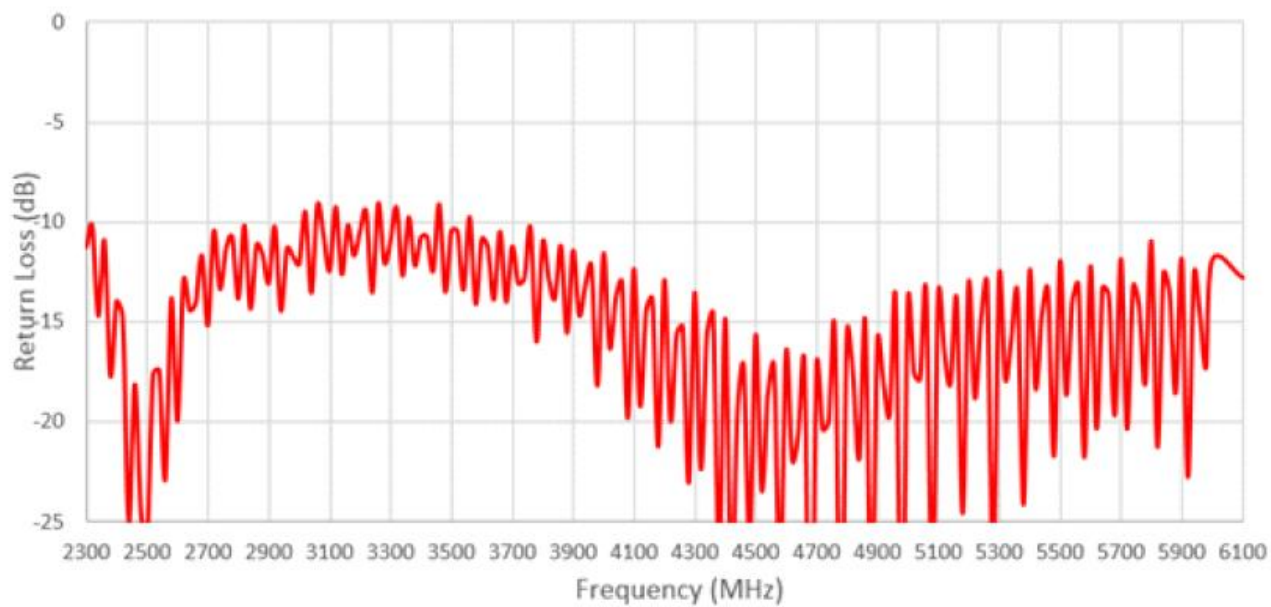

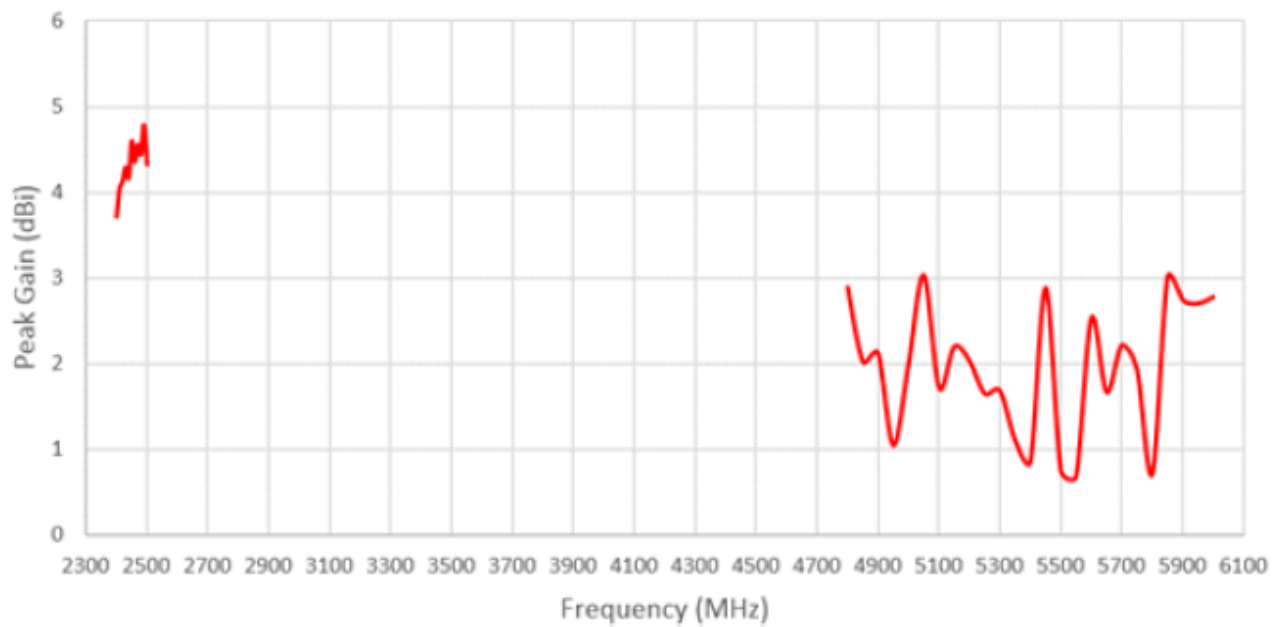
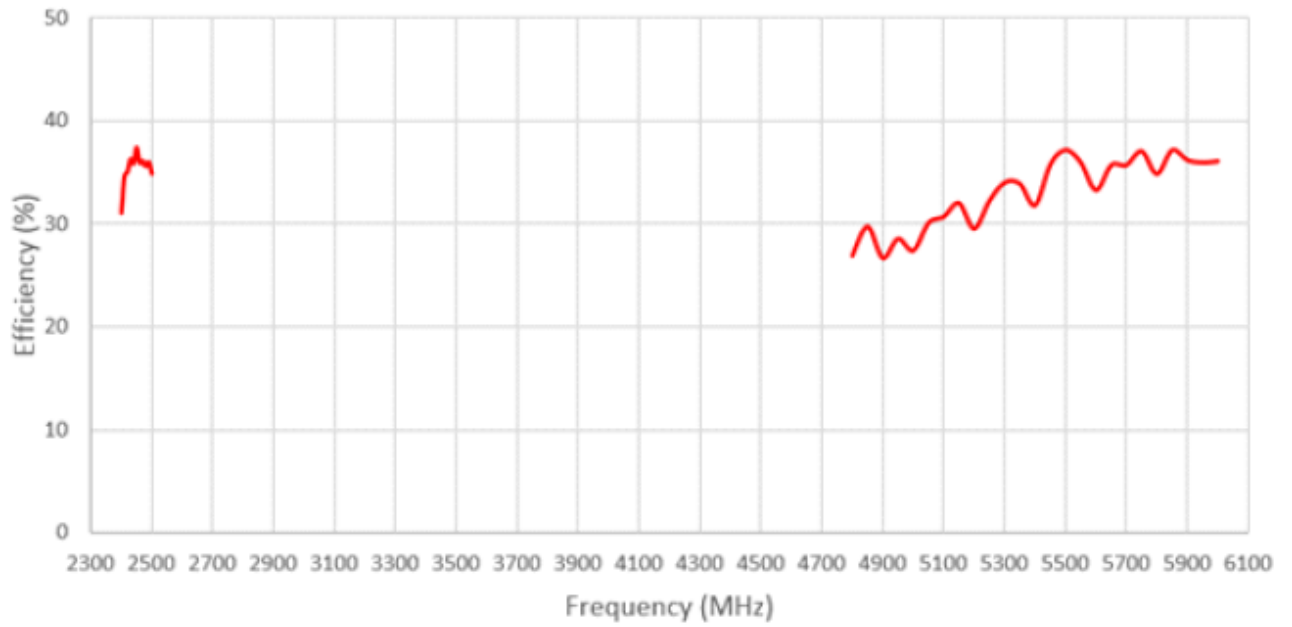

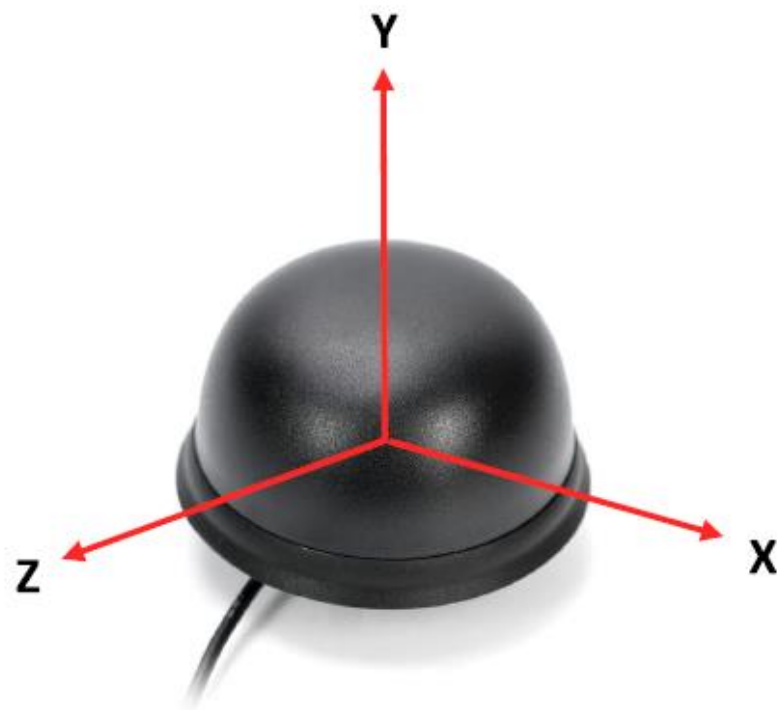
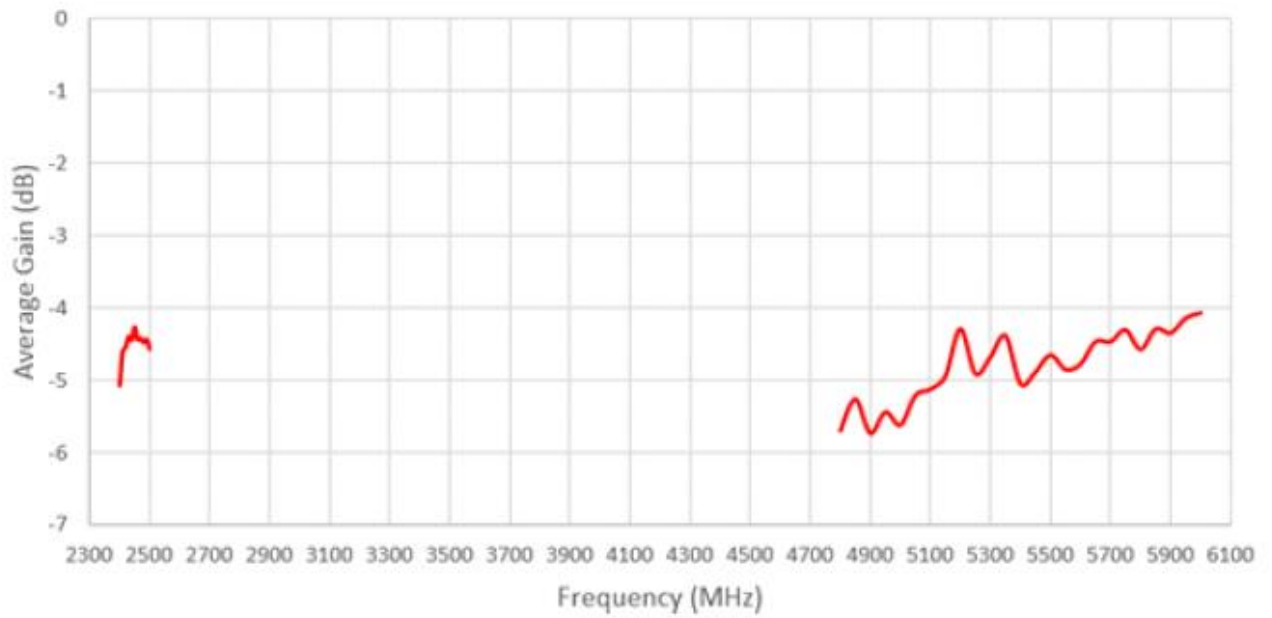

Radiation pattern reference

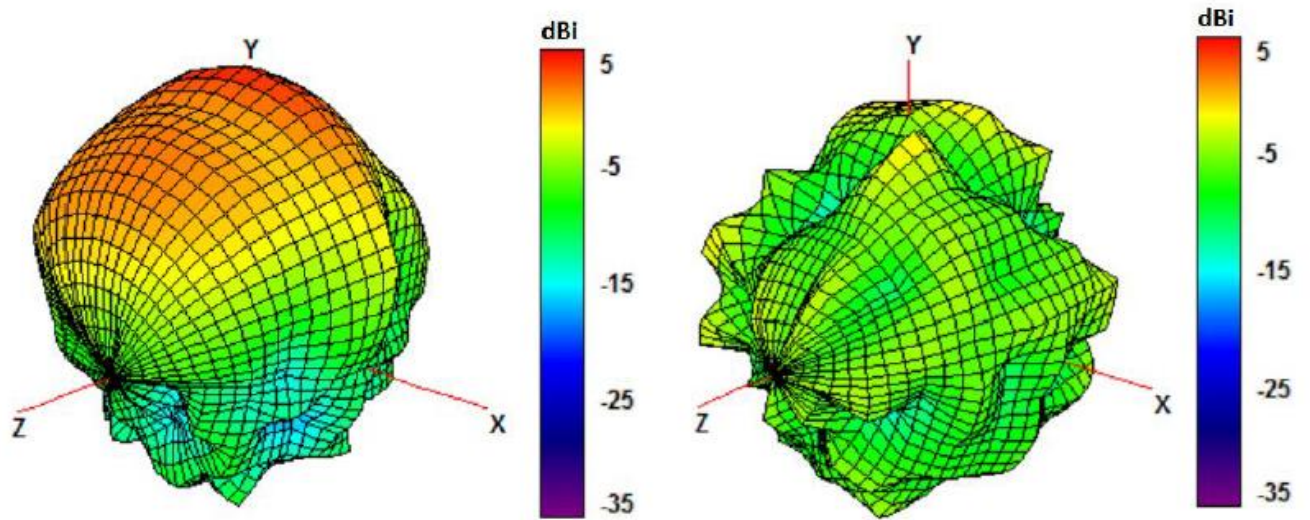

2450 and 5500 MHz Radiation pattern